

Instructions **for Use**

BRUNNER
Pellet heating
BPH 7/24 und BPH 9/30

©2024

BRUNNER[®]
made in germany.



Contents

1	Introduction.....	5
1.1	Purpose of this manual.....	5
1.2	Target audience.....	5
1.3	Validity of these instructions.....	5
1.4	Keeping of documents.....	5
1.5	Symbols and text style rules.....	6
1.5.1	Specified symbols.....	6
1.5.2	Text style rules.....	6
1.6	For your safety.....	7
1.6.1	Dangers and safety measures.....	7
1.6.2	Warnings.....	8
1.6.3	Regulations.....	9
1.6.4	Conformity.....	9
1.6.5	Obligations of our Natural Power Partners.....	10
2	Product description.....	11
2.1	Intended use.....	11
2.2	Type plate.....	12
2.3	Overview of the boiler.....	13
2.4	Safety concept.....	14
2.5	Fuel and water quality requirements.....	15
2.5.1	Pellets.....	15
2.5.2	Heating water.....	15
3	Planning advice.....	16
3.1	Requirements for the installation site.....	16
3.2	Minimum clearances.....	16
3.3	BPH separator (UE10160).....	18
3.4	Hydraulic diagrams and wiring diagrams.....	19
4	Operation basics.....	21
4.1	Licenses.....	21
4.2	Touch-sensitive display.....	22
4.3	Display overview.....	23
4.3.1	Buttons.....	24
4.3.2	Combustion chamber - display views.....	27
4.3.3	Ash box - display views.....	28
4.4	Heating display views.....	28
4.4.1	Heating control panels.....	29
4.5	Display views Pellet storage.....	30
4.5.1	Daily pellet container.....	30
4.5.2	Annual pellet hopper/weekly hopper.....	32
4.6	Own settings.....	34
4.6.1	Individualisierung des Displays.....	34
4.6.2	Locking the boiler - for filling the pellet store.....	40
4.6.3	Exhaust gas test.....	41

4.6.4	Selecting or creating new heating programs.....	43
4.6.5	Setting the program for hot water.....	45
4.6.6	Absence time.....	46
4.6.7	Lowering type.....	48
4.6.8	Summer/Winter switching.....	49
4.6.9	Permanent.....	49
4.6.10	Heating circuit frost protection.....	49
4.6.11	Disinfection.....	49
4.7	Remote access via myBRUNNER.....	50
4.7.1	Preconditions and instructions.....	50
4.7.2	Registration.....	51
4.7.3	Logging in.....	62
4.7.4	Enabling for Service access.....	64
4.7.5	Connect keypads to the Internet.....	66
	4.7.5.1 Activate WLAN.....	67
4.7.6	Brunner App.....	68
4.7.7	Network adverts.....	68
4.7.8	Synchronisation with network.....	69
4.8	Data protection declaration of Ulrich Brunner GmbH.....	69
5	Information and error messages.....	71
5.1	List of error codes and rectification.....	71
5.2	Acknowledge error messages BPH.....	76
5.3	Communication of the system.....	76
6	Cleaning and maintenance.....	78
6.1	Cleaning and maintenance intervals.....	78
6.2	Cleaning tool.....	80
6.3	Emptying the ash box.....	80
6.4	Ash disposal.....	83
6.5	Operation with electrostatic separator.....	84
6.6	Notes on the update.....	85
	6.6.1 Software from PC on the USB-Stick.....	85
	6.6.2 Transfer the software from the USB stick to the control panel.....	87
	6.6.3 What to do if the update does not start?.....	87
7	Decommissioning.....	89
7.1	Temporarily take the boiler out of operation.....	89
7.2	Decommissioning the boiler.....	89
7.3	Waste disposal.....	90
	7.3.1 Disposing of packaging.....	90
	7.3.2 Disposing of boilers.....	90
8	Technical and commercial data.....	91
8.1	Declaration of Conformity BPH.....	91
8.2	Dimension sheets.....	92
	8.2.1 BPH separator (UE10160).....	93
8.3	Technical data BPH 7/24 and BPH 9/30.....	93

1 Introduction

1.1 Purpose of this manual

This document contains information about the BRUNNER Pellet-heating BPH 7/24 und BPH 9/30. Among others, you will find here information about:

- Safety and risks
- Assembly, installation and commissioning
- Product description and principles of operation
- Operating instructions and control description
- Cleaning and maintenance
- Fault finding and troubleshooting
- Decommissioning and disposal
- Technical and commercial data

1.2 Target audience

This document contains also information for the User of the heating system.

1.3 Validity of these instructions

This technical documentation is valid for the BRUNNER pellet heating BPH 7/24 und BPH 9/30 starting from October 2019.

Ulrich Brunner GmbH reserves the right to introduce technical changes, as far as they serve for technical progress, or if they are required by technical safety provisions.

1.4 Keeping of documents

IMPORTANT

READ CAREFULLY BEFORE USE

KEEP FOR FUTURE REFERENCE

The User is responsible for keeping of the BRUNNER pellet heating BPH 7/24 und BPH 9/30 documentation, as well as all other important documents.

1.5 Symbols and text style rules

1.5.1 Specified symbols

In this documentation, a distinction is made between:

Operating personnel as the **User of the system**, i.e. the end user, which has received instructions from the Contractor and does not necessarily have additional qualifications.

Operating personnel as the **Contractor**, i.e. the qualified professionals, which are entitled to perform the indicated specialist works.

In this document, the following symbols are used:



DANGER

A danger of high risk persists, which leads to severe injury or death, if this endangering situation is not avoided.

WARNING

A danger of medium risk persists, which can lead to severe injury or death, if this endangering situation is not avoided.

CAUTION

A danger of low risk persists, which can lead to minor or moderate injury, if this endangering situation is not avoided.



ATTENTION

There is a certain risk, which can lead to a malfunction or damage of the related system and all devices connected with it, if the indicated notifications are not followed.



NOTE

Additional helpful information

1.5.2 Text style rules

In this document, the following text style rules are in use:

Handling or operating instructions with several steps

Descriptions of operations or actions with several steps, when these steps must be performed in chronological sequence.

1. First working step;
 2. Second working step;
 3. Third step.
- Final result

Appearance of on-screen display text in this manual

For descriptions of settings performed on the BRUNNER Touch Display, the displayed text is shown as bold letters.

1.6 For your safety

1.6.1 Dangers and safety measures

Assembly, installation and maintenance may only be carried out by a specialist company.

- Only carry out activities that are described in these instructions.



Electric shock

Work on the electrical installation may only be carried out by a qualified specialist company.

- The electrical connections are live. This can lead to an electric shock.
- Observe all applicable regulations.



Risk of injury due to scalding

High water temperatures can lead to scalding. Small children or elderly people can be at risk even at lower temperatures.

- Do not set the hot water temperature of a connected hot water storage tank higher than 65°C.



Avoid damage to the appliance and resulting hazards

Sprays, solvents or cleaning agents containing chlorine, paints, adhesives etc. can cause damage to the appliance under unfavorable circumstances.

Under no circumstances should you make any changes to parts or equipment of the heating system if these changes could impair operational safety.



Risk of frost

If the BPH remains out of operation in an unheated room for an extended period of time (e.g. during the vacations), the water in the pipes may freeze. Freezing water can damage the pipes and cause consequential damage.

- Inform the operator about the frost protection of the heating system.
- Install the BRUNNER pellet heating system in rooms with an ambient temperature of 5 °C to 40 °C.



DANGER

This appliance can be used by children aged from 8 years and above and persons with reduced physical, sensory or mental capabilities or lack of experience and knowledge if they have been given supervision or instruction concerning use of the appliance in a safe way and understand the hazards involved. Children must not play with the appliance. Cleaning and operator maintenance must not be carried out by children without supervision.



Risk of injury from burns

Contact with hot surfaces of the boiler can cause burns.

- Do not touch the boiler's flue gas pipe, especially if it is not insulated.
- Allow the boiler to cool down and wear protective gloves before removing the ash.
- Allow the boiler to cool down or wear protective gloves before carrying out cleaning and maintenance.

1.6.2 Warnings

Warnings in this document are emphasized by pictographs and signal words.

The pictograph and the signal word indicate the type, the source or causes of a certain action. The necessary measures or calls for action are indicated.

The result or purpose is shown as well. These warnings refer to possible misuse of the system, which seems likely based on our experience. The residual risks are indicated too.

The residual risks remain:

- despite the means for integration of safety during construction,
- despite the safety precautions,
- despite the additional protective measures.

For certain points, there are also given some recommendations and instructions on the application of protective measures, including personal protective equipment. Special safety instructions and recommendations are applied for transport, handling and storage. Instructions for safe setup and maintenance include separate protective measures too.

Structure of warnings

The warnings that precede each assembly step, are shown as follows:



Hazard for humans

Type, source and causes of danger

Measures

Calls for action

→ Result or safe use



Hazard for the system

Type, source and causes of danger

Measures

Calls for action

→ Result or safe use

1.6.3 Regulations

Among others, the following regulations and guidelines must be observed during installation, commissioning and maintenance of the BPH 7/24 und BPH 9/30 :

Legal requirements:

- the legal regulations for accident prevention
- the legal regulations for environment protection
- the provisions of the industry associations
- the "Energy Saving in Buildings" law (Energieeinsparungsgesetz-EnEG)
- the Energy Saving Act (Energieeinsparverordnung)
- the Master Fireplace Act (MFeuVo) of the respective Federal Countries (FeuVo)
- the Country Building Code and the list of technical building regulations
- the governmental, regional building codes and boiler room equipment listings.

Standards and Guidelines:

- the relevant safety conditions included in DIN, EN, DVGW, TRI and VDE standards
- DIN EN 12828 Heating systems in buildings - Hot-water heating systems
- BImSchV Federal Immission Control Ordinance
- EN 13384-1 Exhaust systems - thermal and fluidic calculation methods
- DIN 18160-1 Exhaust systems - Part 1: Planning and execution
- EN12831 Heating systems in buildings; Method for calculation of the design heat load
- EN14597 Temperature control devices and temperature limiters for heat generating systems
- DIN 4753 Water heating systems for drinking and process water
- DIN 4109 Sound insulation in buildings, supplementary sheets and permissions
- DIN 1988 Technical rules for drinking water installations (TRWI)
- DIN EN ISO 4126 or TRD 721- Safety devices for protection against excessive pressure - Safety valves
- Details Norm: DIN VDE 0100-540 VDE 0100-540:2012-06 Setting up low voltage installations
- DIN VDE 0100 Teil 701 DIN VDE 0100-710 Low voltage installations
- DVGW worksheets W551 and W552 Technical measures to reduce the growth of Legionellae
- VDI 2035 Prevention of damage in hot-water heating systems
- VDI 4708 Heating equipment - pressure maintenance, venting, degassing.

1.6.4 Conformity



Hereby we declare as the manufacturer that this product - BRUNNER pellet heating BPH 7/24 und BPH 9/30 complies with the basic guidelines for sale in the EU.

1.6.5 Obligations of our Natural Power Partners

To ensure the proper functioning of the BPH 7/24 und BPH 9/30 , observe the following guidelines:

- Perform works only if you have the necessary expertise.
- Perform only such activities, which are indicated or described in this manual.
- Please ask an expert for instructions on the operation and maintenance of the system and potential hazards that may arise during operation.

2 Product description

2.1 Intended use

The BRUNNER pellet heating system BPH 7/24 und BPH 9/30 has been designed and constructed in accordance with the generally recognized rules of technology and the recognized safety regulations.

The BRUNNER pellet heating system is intended for heating domestic hot water and drinking water in single or multi-family houses or commercial buildings.

Intended use also includes compliance with the operating instructions and operating manual associated with the boiler.



NOTE

The operator of a Brunner boiler is obliged to regularly service and maintain the system in accordance with the Ordinance on Energy Saving Thermal Insulation and Energy Saving Systems Technology in Buildings (Energy Saving Ordinance - EnEV) § 11. We recommend the conclusion of a maintenance agreement between the specialist tradesman and the operator of the heating system.

Improper use:

The BRUNNER pellet heating system BPH 7/24 und BPH 9/30 is not intended to:

- directly heat drinking water;
- burn fuels other than those specified in the technical documentation.

Any other use of the boiler is not permitted. The manufacturer is not liable for any resulting damage to property or personal injury.

Non-compliant operation may result in danger to life and limb of the operator or third parties or damage to the boiler.

Any other use or modifications to the product, including during assembly and installation work, will invalidate all warranty claims.

2.2 Type plate

The type plate is located on the ash door, clearly visible after opening the cladding door.



Ulrich Brunner GmbH
Zellhuber Ring 17-18
D-84307 Eggenfelden

EN 303-5

Holzpelletkessel: **BPH 7/24**
 Wärmeleistungsber.: 7 kW - 24 kW
 Feuerungsleistungsber.: 7 kW - 26 kW
 Kesselklasse: 5
 Brennstoffklasse: EN 14961-2 A1
 zul. Betriebsüberdruck: 3 bar
 zul. Betriebstemperatur: 75 °C
 Wassereinhalt: 78 Liter
 Betrieb: Heizkessel mit Gebläse
 Betriebsart: nicht kondensierend
 Kesselkategorie: 3
 Netzanschluß: 230 VAC, 1,6 A, 50 Hz
 Herstellnummer:

Illustration 1: Type plate BPH 7/24



Ulrich Brunner GmbH
Zellhuber Ring 17-18
D-84307 Eggenfelden

EN 303-5

Holzpelletkessel: **BPH 9/30**
 Wärmeleistungsber.: 9 kW - 30 kW
 Feuerungsleistungsber.: 10 kW - 32 kW
 Kesselklasse: 5
 Brennstoffklasse: EN 14961-2 A1
 zul. Betriebsüberdruck: 3 bar
 zul. Betriebstemperatur: 75 °C
 Wassereinhalt: 78 Liter
 Betrieb: Heizkessel mit Gebläse
 Betriebsart: nicht kondensierend
 Kesselkategorie: 3
 Netzanschluß: 230 VAC, 1,6 A, 50 Hz
 Herstellnummer:

Illustration 2: Type plate BPH 9/30

It contains the following important information

- CE mark;
- Recycling symbol;
- Manufacturer's data;
- Designation;
- Nominal heat output range;
- Nominal firing output range;
- Boiler class;
- Fuel class;
- Approved operating pressure;
- Approved operating temperature;
- Water content of the boiler;
- Operating mode;
- Required mains connection;
- Current manufacturing number of the existing boiler

2.3 Overview of the boiler

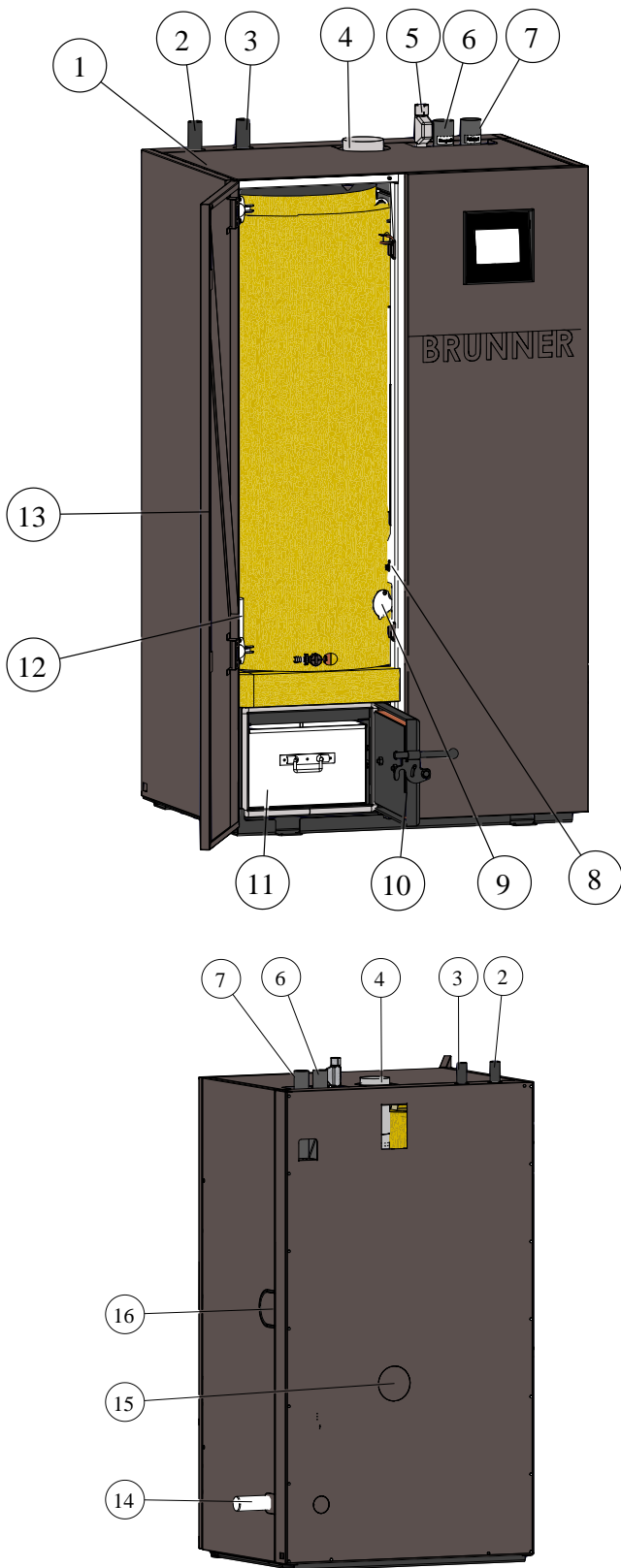

Pos.	Designation
1	Boiler cladding
2	Buffer loading return
3	Buffer loading flow
4	Flue gas connection
5	Cold water for heat exchanger flushing, connection safety hose with solenoid valve included with the boiler
6	Pellet feed
7	Return air pellet feed
8	STB button (safety temperature limiter)
9	Inspection hole
10	Ash door
11	Ash box
12	Cleaning tool
13	Cladding door
14	Waste water connection with siphon
15	Recess for connections: external supply air
16	Recess for connections: Exhaust gas connection

2.4 Safety concept

The detailed safety concept of the boiler control system ensures continuous monitoring and control of all operating states and all connected sensors, fans and drives.

The primary aim is to control the combustion process and to comply with the safety requirements, including EN 303-5 (“Boilers - Part 5: Boilers for solid fuels, manually and automatically fired, nominal heat output up to 500 kW”).

If required, the following functions are also controlled automatically:

- Heat removal (with boiler pump)
- Boiler cleaning (grate and heat exchanger cleaning)
- Filling the storage tank
- Control of the pellet feed to the combustion chamber
- Automatic ignition
- Flue gas fan control
- Potential-free contact for external fault evaluation.

Control, communication and monitoring functions are automatically activated by appropriate configuration during installation/commissioning.

All operating states as well as the current operating parameters are shown on the touch display. If operating faults occur, the error messages appear on the display and warning signals sound.

All information and error messages are automatically saved in the archive and can be retrieved from there for error assessment.

Software can be updated at any time via the existing USB port.



NOTE

Necessary safety devices in accordance with EN 12828 (“Heating systems in buildings”), which are not part of the scope of delivery, must be provided by the customer. All safety devices must be professionally installed and checked for proper function at least once a year. Expansion vessels, expansion pipes, safety valves and blow-out pipes must be protected against freezing, e.g. by being installed in a frost-proof boiler room.

The safety temperature limiter (STB) is a component that interrupts the control operation of the boiler. This protects the boiler itself, or the system connected to it, from damage. Accordingly, the STB only becomes effective if the actual temperature controller should fail.

The boiler can only continue to operate if the safety temperature limiter is switched back on manually. The boiler safety group also protects the heating circuit.

The blow-out line consists of the lines between the safety valve and the boiler.

The following applies to the blow-out line:

Nominal diameter [DN]	Max. Length [m]	Max. Number of bends [pieces]
20	2	4
25	2	4

2.5 Fuel and water quality requirements

2.5.1 Pellets

Wood pellets are a modern, environmentally friendly and standardized wood fuel. They are mainly pressed from the bark-free sawdust from sawn timber production. The strength of the wood pellets is ensured by the lignin contained in the wood, supported by the small addition of natural binding agents such as starch.

Quality classes of the pellets



The BRUNNER BPH pellet heating system may only be operated with wood pellets that comply with the DIN EN 14961-2/ A1 standard or the international DIN EN ISO 17225-2 standard and have a diameter of 6 mm.

Only purchase wood pellets from suppliers who can guarantee their high quality.

The following certificates stand for assured pellet quality (wood pellets for use in small fires):



ENplus A1 quality certificate with
ID number of a certified
German pellet dealer:



2.5.2 Heating water

Heating water

In modern heating systems, the quality of the heating water has a significant influence on the functionality and service life of the heating system due to the combination of different heat generators and components such as high-efficiency pumps or modern sensor technology. For this reason, there are corresponding national specifications such as VDI 2035 in Germany, ÖNORM H 5195-1 in Austria and similar regulations.

BRUNNER therefore recommends filling and refilling the heating system with appropriately treated water.

Drinking water analyses for the respective supply area can be requested from the responsible water supply companies.

3 Planning advice

3.1 Requirements for the installation site

The boiler may only be installed in a dry environment.

The permissible ambient temperatures are between +4°C and +30°C.

The floor must be level, sufficiently stable and non-flammable. Stability and stability must be ensured from the start. If the ceiling load is not sufficient, suitable measures must be taken to distribute the load.

The installation room must have adequate local lighting.

The combustion air must be technically free of chemical substances containing fluorine, chlorine, sulphur, etc.

During operation, the boiler unit is closed and there is no risk of injury due to imbalance of rotating parts.

The boiler must not be installed in rooms in which:

- the required combustion air supply is not guaranteed.
- highly flammable or explosive substances are stored, manufactured or processed.
- **in the case of room air-dependent operation**, room air systems such as extractor hoods or controlled ventilation systems are installed. This is only permitted if the safe operation of the boiler is ensured, if
 - the ventilation and air conditioning systems only circulate air within a room;
 - the ventilation and air conditioning systems have safety devices that automatically and reliably prevent negative pressure in the installation room;
 - simultaneous operation of the fireplace and the ventilation and air conditioning systems is prevented by safety devices;
 - the total negative pressure does not exceed 4 Pa - the negative pressure is created by the combustion air flow of the boiler and the volume flows of the ventilation systems in the installation room and in the rooms connected via the ventilation network.



Inform the responsible district chimney sweep about the installation of the boiler before planning the system.

Ask him for advice regarding the planned installation room, connection and suitability of the chimney and an adequate supply of combustion air.

3.2 Minimum clearances

It is necessary to adhere to the minimum clearances when setting up the boiler in order to ensure accessibility for maintenance and service work on the boiler.

Exhaust systems must be easily accessible for the chimney sweep for measuring, checking and cleaning work. A suitable stand area should therefore be planned.

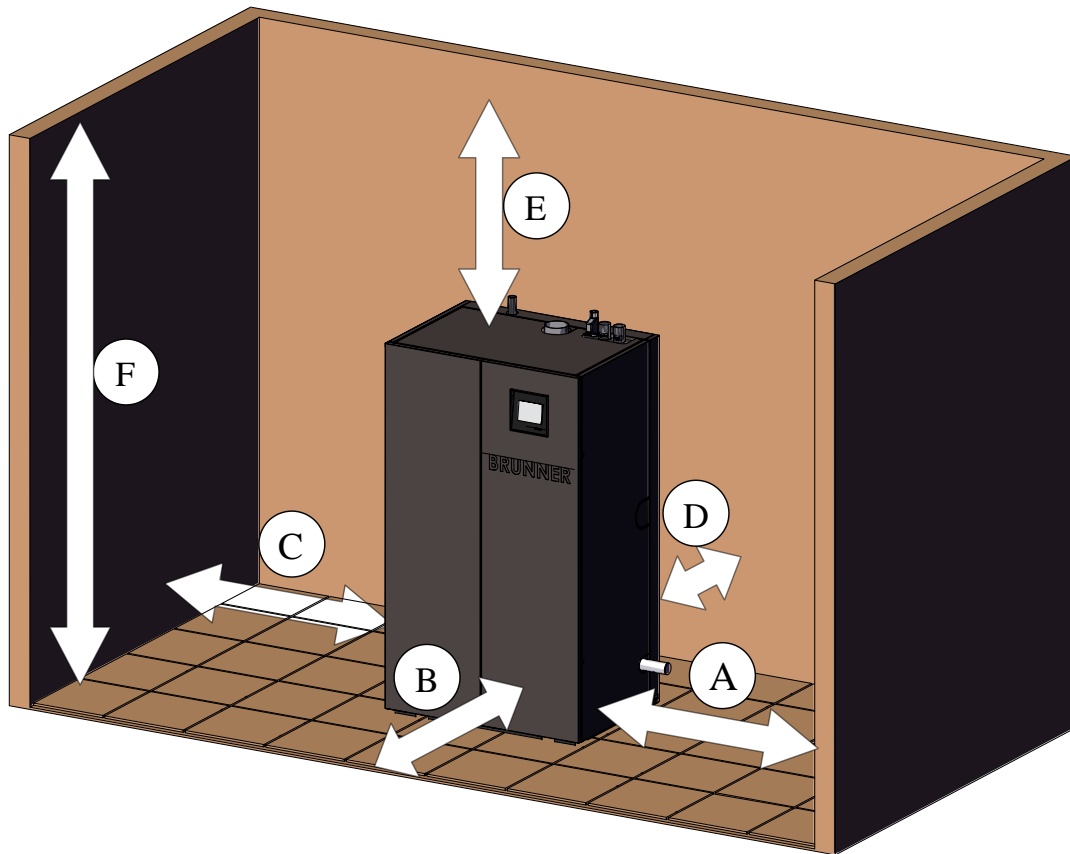

A	500 mm	Maintenance side
B	600 mm	Operating side
C	50 mm	Wall clearance
D	50 mm	Wall clearance
E	367 mm	Maintenance (removal of heat exchanger-cleaning)
F	2000 mm	Resulting room height

Distances to fuel stores

The Model Firing Ordinance (MFeuV) is decisive for the minimum distances between fireplaces and flue systems to combustible components or fuel stores.

Distances to fuel stores conform §12 (3):

If fireplaces are set up in the rooms in accordance with Paragraph 2 No. 2 to 4, these must:

- be outside the required collecting areas for leaking fuel and
- have a distance of at least 1 m from containers for heating oil or diesel fuel.

A distance of 0.1 m is sufficient if it has been proven that the surface temperature of the fireplace does not exceed 40° C.

3.3 BPH separator (UE10160)

Separator with BPH 7/24 or BPH 9/30:

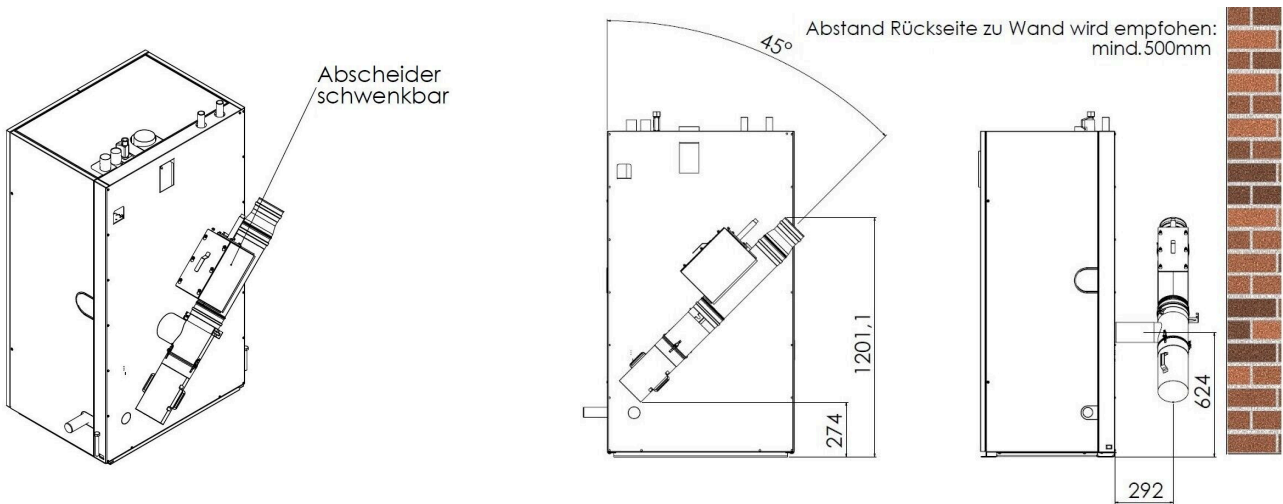
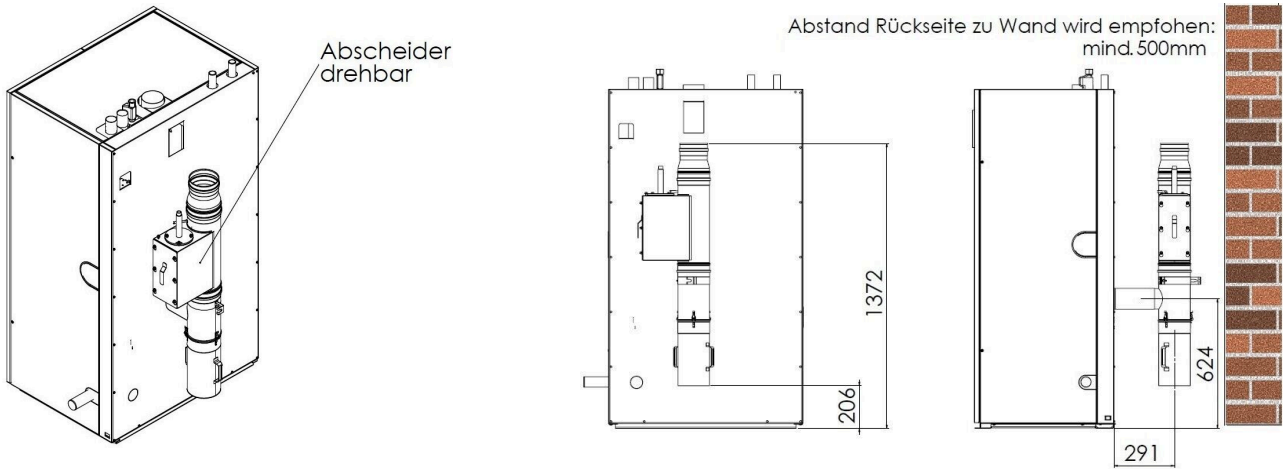

Condensate lifting unit



- Waste water lifting unit for above-floor installation, type: SWH 100
 - Collecting tank made of PP with approx. 10 l usable capacity
 - Switching device integrated in the tank cover with acoustic alarm signal in the event of an impermissibly high water level
 - Potential-free contact for external alarm
 - Simple installation and maintenance thanks to DN 40 sliding piece for the washbasin inlet connection
 - Easy to maintain, thanks to pump mounted directly on the cover
 - separate appliance connection with hose nozzle
 - prepared shower inlet DN 50 that can be used on both sides (only 80 mm from the bottom edge of the tank to the middle of the shower inlet pipe)
 - 1 ¼" pressure outlet with integrated non-return valve
 - tank ventilation via activated charcoal filter
- Scope of delivery:
- 1.5 m connection cable with Schuko plug
- Voltage: 230 V
 Motor power P1: 300 W and motor power P2: 130 W
 Rated current: 1.3 A
 Speed: 2800 1/min
 Max. Max. delivery head: 6.0 m and max. delivery rate: 8.0 m³/h
 Max. media temperature: 40°C (briefly 90°C)
 Grain size: 10 mm; individual weight per LME: 5.0000

Electrical connection diagram between BPH and condensate lifting unit:

Info:

Disconnect the existing bridge from STP8 before connecting.

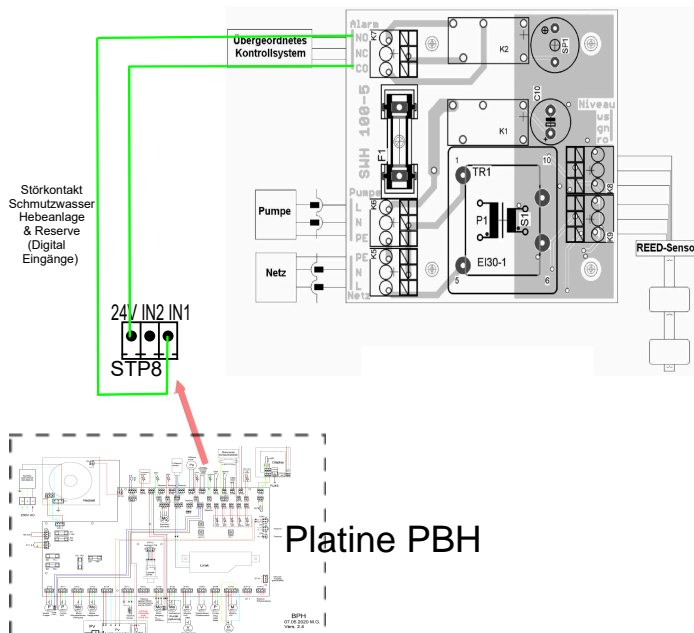

Follow the manufacturer's technical instructions!

3.4 Hydraulic diagrams and wiring diagrams

Hydraulic diagrams and the relevant wiring diagrams can be found in the BRUNNER Hydraulic Manual:

The BRUNNER Hydraulic Manual is currently in the craftsmen's area at:

<https://www.brunner.de>

BRUNNER Hydraulic Manual 2020:

<https://www.brunner.de/11596>

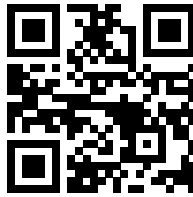

BRUNNER Hydraulic Manual 2022:

<https://www.brunner.de/11597>

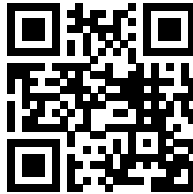

4 Operation basics

The images shown in the installation and operating instructions (including display views) do not claim to be an exact representation of the displays on your system. These depend on the installed system components, their measurement functions, control variants and set parameters. In some cases, these system parts are not part of the standard versions, but are provided as optional accessories.

4.1 Licenses

For the visualization of our user interface we use an open source operating system, which is subject to different license models.



You can see the licenses used in the software under the menu:
„**Settings**“ → “**Display**“ → “**Licenses/Contact**“

Written Offer (open source software)

Our product contains software and sourcecode whose rightholders license it under the terms of the GNU General Public License, version 2 (GPLv2), version 3 (GPLv3), the GNU Lesser General Public License, version 2.1 (LGPLv2.1), version 3 (LGPLv3) and other open source software licenses.

If you send us a request for oversending the licensed source code of the software, please use the following address:

Ulrich Brunner GmbH
Zellhuber Ring 17-18
84307 Eggenfelden
info@brunner.de

Upon request, we will send you a CD-ROM with the provided source codes. You have to pay the costs for material, packaging and delivery.

The offer is valid for at least three years from the date of delivery of the product on which the software is installed, and as long as we can offer spare parts and customer service for this product, or from the time of downloading the software from our homepage.

Please include the type of product for which you want to receive the source code in your request.

4.2 Touch-sensitive display

The BPH 7/24 und BPH 9/30 is equipped with a touch-sensitive display to make operation simple and easy to understand. The touch-sensitive display is a combination of input and output device, which enables direct control of regulatory functions by touching the screen itself or certain parts of displayed screen.

The controls are activated directly by tapping or touching. You can do it with your finger, or using a special stylus.

To indicate the selected option, the corresponding softkey will shortly change its colour **to orange** when tapped (or touched) and then will turn **dark**.

Available softkeys are represented by: symbols (e.g. Home, Sensors, Menu, etc.), sliders, check boxes, text or number fields, or key pads.



Illustration 3: Display operation by tapping, touching or pressing



Illustration 4: Display operation with sliders

4.3 Display overview

Home view for BPH (standard)

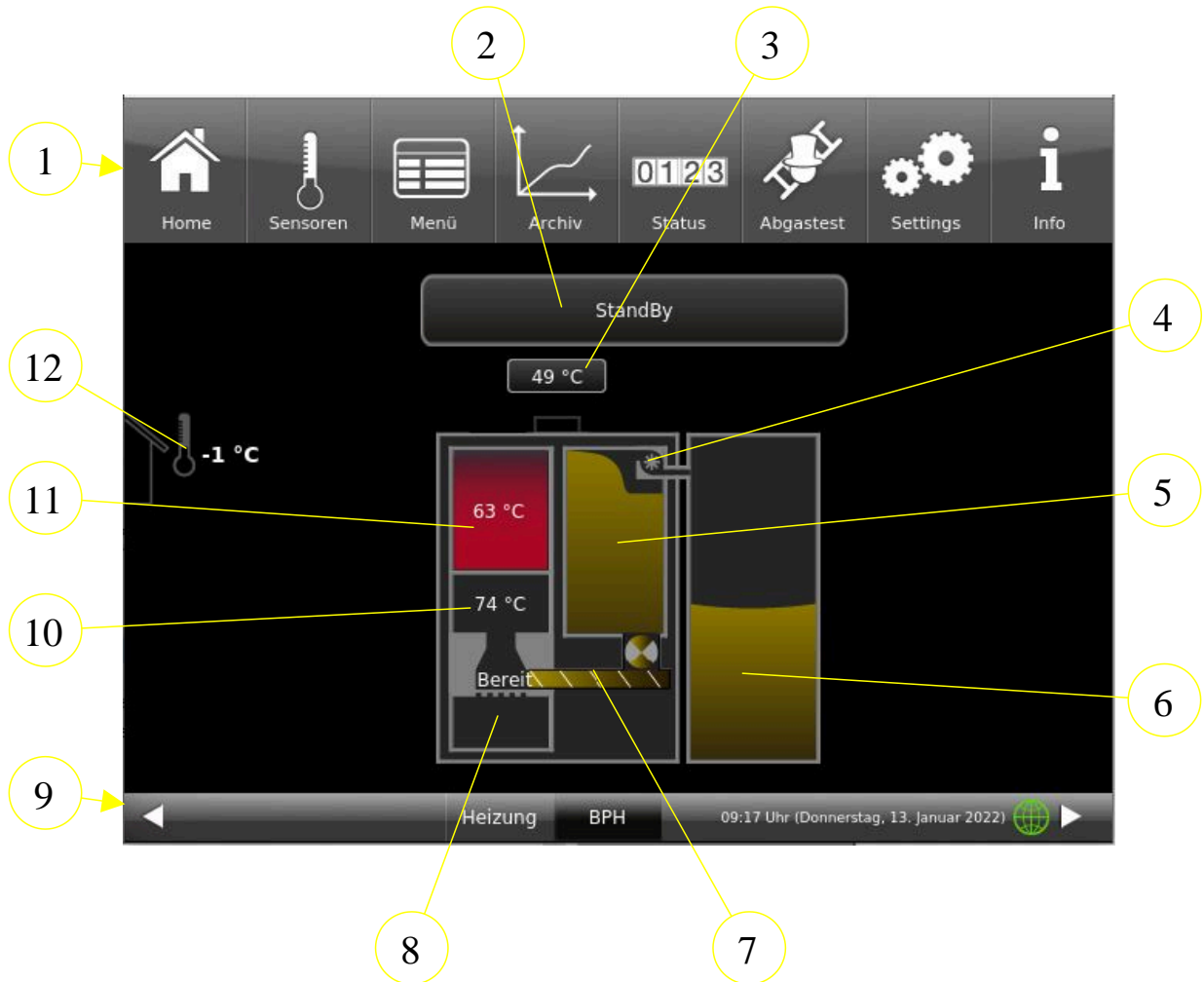

Pos.	Designation	Function
1	Upper menu bar	Buttons with direct access to sensors, menu, archive, status, etc. - For details, see chapter "Buttons"
2	Operating status	Display of the current operating status and service displays
3	Exhaust gas temperature	Current temperature of the exhaust gases in °C
4	Pellet suction turbine	Shows graphically whether the suction turbine is active (green) or switched off (gray)
5	Daily pellet container (pellet storage)	The fill level of the daily container is displayed graphically
6	Pellet store	The fill level of the pellet store is displayed schematically; different fill levels are displayed depending on the actual level.
7	Screw conveyor for feeding pellets into the combustion chamber	Graphic animation of the pellet screw conveyor and rotary valve. When the spiral of the screw and the 8-chamber rotary valve are moved, the pellets are fed into the combustion chamber from the side.
8	Ash box	Status of the ash box; the filling status of the ash box is shown schematically; information texts appear when emptying is required

Pos.	Designation	Function
9	Lower menu bar	Buttons with direct access to the BPH or heating page - for details, see the "Buttons" chapter
10	Combustion chamber	Status of the combustion chamber (off, ready, active; ignition phase, control mode) and combustion chamber temperature
11	Boiler temperature = flow temperature	Boiler temperature in °C; also displayed in color; (blue = cold; red = hot)
12	Outdoor temperature	Current display of the outside temperature

The measured values displayed may deviate slightly from the actual value.

4.3.1 Buttons

You can access further information areas by tapping on the following marked fields:

- All sub-levels of the upper menu bar;
- Changeover to any connected heating system (BHZ) (lower menu bar **Heating**),
- Information on the daily pellet container for pellet storage,
- Information on the annual pellet container for pellet storage,
- and much more.



Illustration 5: Display with active buttons

The top menu bar consists of the following icons:

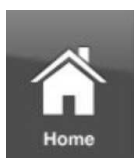

Home view

is the start page and the starting point for all applications;

This button displays a schematic view of the boiler system.

The fields with texts and values provide information about the current operating mode of the boiler (e.g. operating mode, temperature measurements at various measuring points)

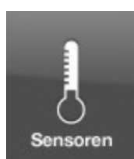

Sensors

In the Sensors view, all sensor values (measured and calculated values) are listed with the associated numerical value, including their unit. A graphic preview is also displayed on the right-hand side of the sensor field.

The following parameters can be read on this page: Boiler output, boiler temperature (°C), temperature in the combustion chamber (°C), temperature of the flue gases (°C); lambda probe (% residual oxygen content); return temperature (°C) and temperature in the top buffer tank (°C).

Proceed as follows to select a sensor value:

1. touch the name of the desired value (e.g. combustion chamber) in the left part of the touch display;
2. for a full view of the graph, touch the area of the graph;

The progression of the selected parameter over time is displayed graphically in the full view.

Note: The scaling automatically adapts to the value and time curve.

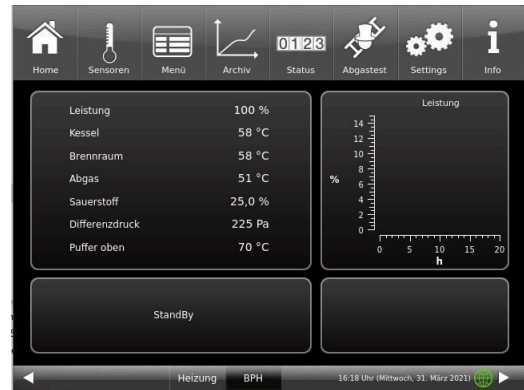

The measured values displayed may deviate slightly from the actual value.

Menu

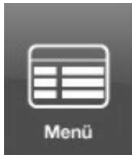

This button enables direct access to the adjustable additional functions (boiler lock; ignition enable; start temperature - see details in the relevant chapters) and view of important parameters: the current value and its setpoint value: boiler (°C); return (°C); combustion chamber (°C); flue gas (°C); lambda probe (%); output control (%); top buffer temperature (°C); middle buffer temperature (°C) and many more. (are sometimes displayed differently - depending on the connected heating control)

Archive



All recorded graphics can be called up in the archive.

The respective sensor graphs are saved under year/month/day/time.

By selecting the year and the corresponding month, you will receive a list of the entries saved in it (day - time).

Archive navigation: Click **Month** to return to the monthly overview and **Years** to return to the annual overview.

The individual burn-up is selected within the archive window (the selected entry is displayed in orange). Depending on the selected sensor value (orange button), the corresponding graphic is displayed in the preview (the default setting is always "Boiler output"). The saved error messages are always displayed in the message window for all sensor graphics.

1	Selection of a parameter to display the development graphic for the selected sensor at a specific time.
2	Preview of the selected graphic; tap on it for a large-screen view
3	Enumeration of the saved error messages
4	Selection of burn-up by date/time
5	Year selection
6	Scroll through the archive

The measured values displayed may deviate slightly from the actual value.



Status

This button provides you with an overview of all operating data (e.g. operating hours, amount of heat generated, number of burn-offs, etc.)

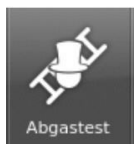

Flue gas test

You can use this button to set the boiler for a flue gas measurement or enter the date for this. You will be reminded 3 or 1 day in advance. You will receive instructions on the necessary preparatory activities. The boiler is automatically started at the right time.

The color of this button shows the current status of the “Flue gas test” function: white = inactive; green = active.



Settings

This button enables settings and access to the boiler configuration.

The parameter levels are only accessible via a PIN.

For the operator: PIN code is **9999**

By entering the assigned setup PIN number, the boiler control system recognizes the respective user. Only certain heating control setting options are enabled for the various users.

Enter the PIN number:

After pressing the **Settings** button, the following numeric keypad appears:
 By tapping the white-marked numeric keypads, they become active and adopt the subsequently selected number;
 Immediately afterwards, press the numbers of your PIN;
 Please note the position of the thousands/hundreds/tens/ones of your PIN number.
 If you want to delete a number, press **Del**;
 If you want to exit the program, press **esc**;
 After entering the number, press **O.K.**

→ Advanced settings are now enabled.



Illustration 6: Enter PIN button

Settings logout

You can exit the Settings function area immediately to log in again with a different PIN if required (setup PIN).

All settings made so far will be saved.

To exit the Settings function area immediately, proceed as follows:

1. Enter the path:

Settings / Control panel / Settings logout

2. Tap the **Settings logout** button;

→ The touch display switches to the Home view.



Info

This button is a help function.

If there are error messages, the Info button is highlighted in orange.

In the case of information texts, the button remains gray and the information messages can be acknowledged.

4.3.2 Combustion chamber - display views



Operating status: *Standby*
 The combustion chamber is cold.



Operating status: *Ignition phase*



Operating status: *Control operation*



Operating status: *Burnout*
 The combustion chamber is warm.

4.3.3 Ash box - display views

The fill level of the ash box is calculated. When the box is 80% full, a message appears on the display: Please empty soon.

If the ash box is full, the boiler start is blocked.

After emptying, the fill level must be reset: Tap on the representation of the ash box on the display (home view) and confirm with "Yes".



4.4 Heating display views

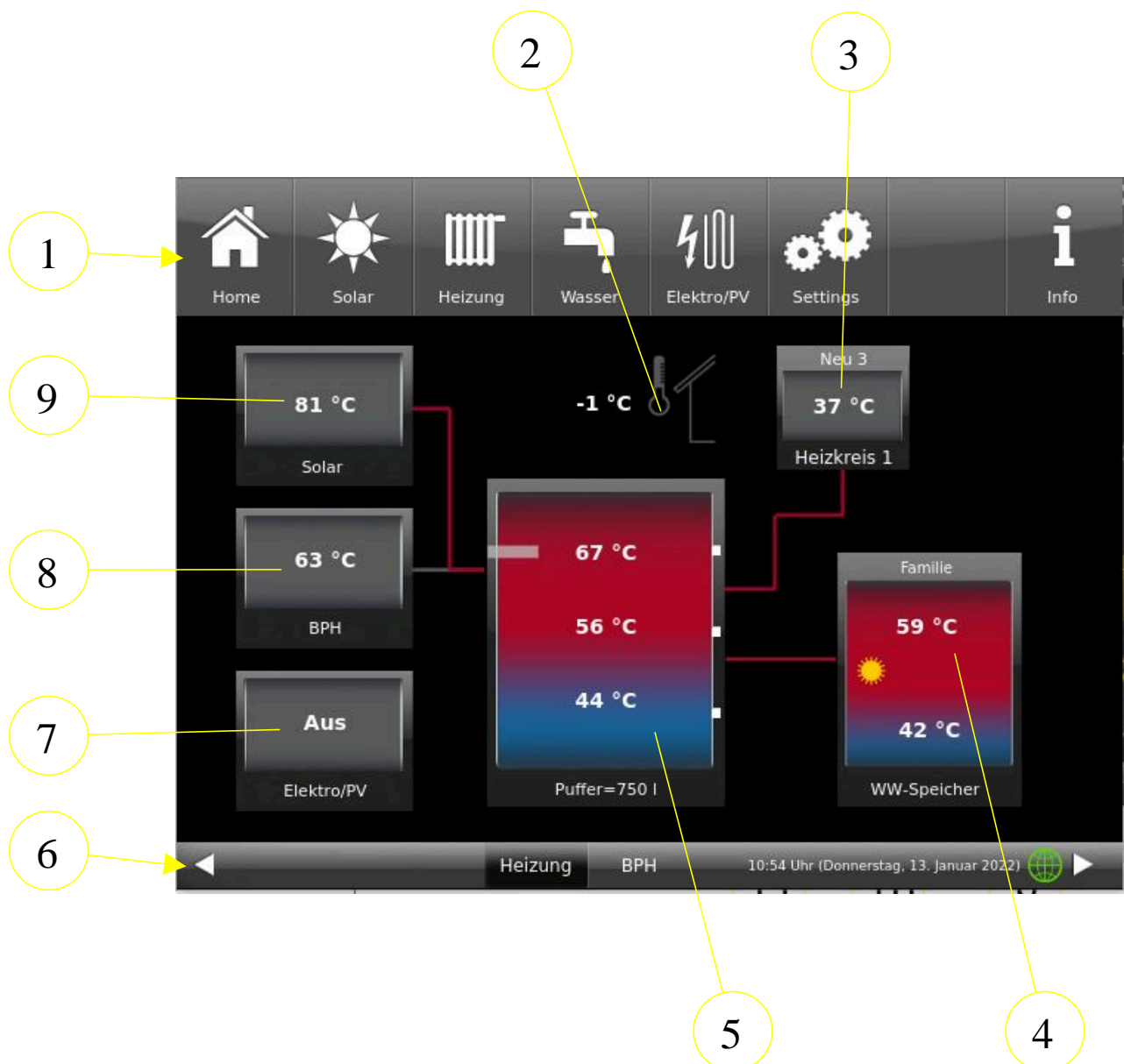

Pos.	Designation	Function
1	Upper menu bar	Buttons with direct access to setting options (for details, see "Own settings" in the operating instructions)
2	Outdoor temperature	Current display of the outdoor temperature
3	Heating circuit	Buttons with direct access to setting options for the heating circuit(s)
4	Hot water cylinder	Buttons with direct access to setting options for the hot water dispenser
5	Buffer tank	Buttons with direct access to the buffer tank setting options
6	Lower menu bar	Switching the home views, etc.
7	Auxiliary heating	e.g. PV system, gas boiler, oil heating, etc.
8	Heat generator	Operating status of the biomass boiler displayed and the type of energy source (BPH) in the footer
9	Solar system	The operating status of the solar system is currently displayed - The type of configured auxiliary heating is listed in text form in the footer

4.4.1 Heating control panels

Depending on the system components installed, there may be small differences in your display view. Example illustration: a BHZ 3.0, which has a log boiler as the energy supplier and the auxiliary heating consists of a solar thermal system and a gas boiler. The energy consumers are 4 heating circuits (the heating) (connected to an EWP-HK) and the hot water station.

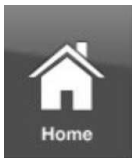

Home view

= start page, starting point for all applications
 = graphical system overview



Solar system (additional heating = heat generator 2)

= button for the existing solar thermal system
 - by tapping this button, the various parameters of the solar system can be accessed.

Auxiliary heating



- Gas boiler
- Oil boiler
- Heat pump
- with electricity



Heating

= Button for setting levels of the existing heating circuits



Hot water

= Button for the DHW heating menu



Settings

- = Button for the setting levels of the various parameters
- = Button for configuring the system
- is only accessible via a PIN (different for the operator and the specialist);



Info

- = a help function
- additional help texts are displayed for the respective active view;
- if there are current error messages, the **Info** button is highlighted in orange.



Heating circuits

- a display/button is provided for each heating circuit. Meaning of the displays: see chapter "Heating circuit display".

Line sections

The color of the line sections changes depending on the status of the corresponding pump or the status of the additional heating. When the pump/booster heater is inactive, the pipe sections are gray. When the pump/auxiliary heater is active, the pipe runs are red.

Arrow to the overall view of the installed system if it is not fully visible in the Home view.



Hot water tank (boiler)

The colors and temperatures displayed are current values.

myBRUNNERr - myBRUNNER status display (online / offline)



gray globe = in the network, regardless of whether WLAN or LAN

green globe = with myBRUNNER local connection

blue globe = online with myBRUNNER

Current time, day of the week, date



Weather

Display of outdoor temperature

If some of the possible system components are missing, these fields remain empty and are listed from left to right in the top menu bar.

4.5 Display views Pellet storage

4.5.1 Daily pellet container

Filling the daily container

The graphic element of the daily container is an active button that can be used to activate or stop filling. If desired, you can also set a blocking time.

An active filling process in the daily pellet container is shown by a green suction turbine and simultaneously with incoming pellets in the upper area.



Illustration 7: Button for filling the daily container



Illustration 8: After tapping the button for the daily container

<p>Pellet filling (= Pellet Befüllung)</p>	<p>Manual filling (= Handbefüllung) = there is no automatic filling, the control system always assumes that there is a sufficient supply of pellets. Automatic filling (= Automatikbefüllung) = filling is carried out by the automatic pellet loading system to convey the pellets from the annual container into the daily container of the pellet boiler.</p> <div data-bbox="603 965 1241 1346" style="text-align: center;"> </div>
<p>Daily container (= Tagesbeh.)</p>	<p>The signal from the fill level sensor is displayed here.</p>
<p>Conveying Allowed (= Fördern erlaubt)</p>	<p>Filling can be enabled(Yes = Ja) or stopped(No = Nein) at any time using the following button.</p> <div data-bbox="1018 1485 1337 1552" style="text-align: center;"> </div>
<p>Blocking time (= Sperrzeit)</p>	<p>Setting a blocking time; selection option: On / Off (= Ein / Aus) = during this period, the pellet transport from the annual container to the daily container of the pellet boiler is stopped due to noise pollution;*</p>
<p>Blocking time start (= Sperrzeit Start)</p>	<p>Start of the blocking time; setting the time using the keypad*</p>
<p>Blocking time end (= Sperrzeit Ende)</p>	<p>End of time; setting the time using the keypad*</p>
	<p>*Selection options only when setting the pellet filling (= Pellet Befüllung) to automatic filling</p>

4.5.2 Annual pellet hopper/weekly hopper

Depending on the pellet extraction system installed in the annual pellet container, different graphics appear on the touch display of the pellet boiler (detailed information can be found in the relevant instructions for the pellet extraction system):

1. annual container with built-in pellet mole system

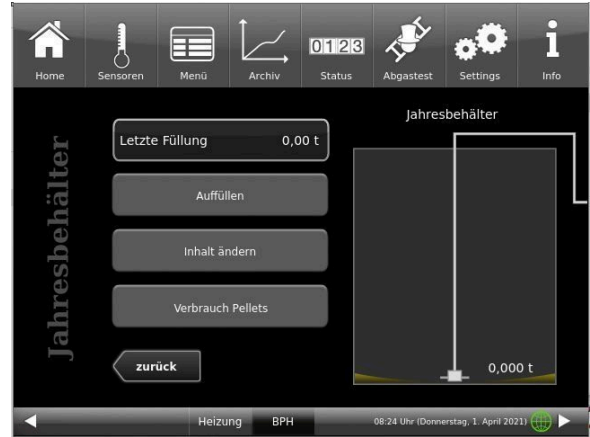

Illustration 9: Display with pellet mole system installed (example with empty annual hopper)

2nd annual container Motorized hose diverter



Illustration 10: Brunner 8 motorized hose diverter



Illustration 11: Brunner 4 motorized hose diverter

3rd annual container as square fabric silo with suction box and vibrating motor or rectangular fabric silo with screw conveyor and T-suction piece







Illustration 12: Annual container fabric silo

4. annual container with externally controlled suction probes



The measured values displayed may deviate slightly from the actual value.

Graphic element	Explanations
	<p>The status of the suction turbine for filling the daily container (top left). Green = active; gray = inactive. Note: this button can also be used for manual start/stop of the suction fan.</p>
	<p>The fill level of the daily container is displayed graphically. The current fill level is determined by calculating the difference to the amount of pellets consumed.</p>

Graphic element	Explanations
	<p>The current fill level in the annual container is determined by the difference between the last fill level specification and the pellet quantity consumed afterwards.</p>
	<p>If the pellet quantity in the daily container is not calculated, this display appears in the daily container. The same display also appears for emergency filling.</p>

Pellet store (annual container) and daily container are almost full:

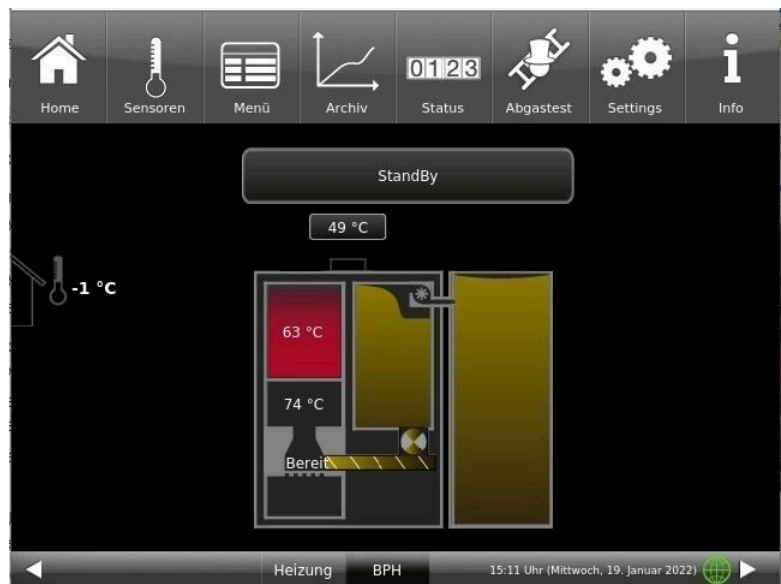

4.6 Own settings

To make certain settings, you have access to the most important levels. The buttons with a white background and the subsequent dialog window with a help text will help you.

Your specialist company can advise you on menu navigation.

PIN code for the operator : 9999

4.6.1 Individualisierung des Displays

The operating display of the pellet heating BPH 7/24 und BPH 9/30 can be customized with various display options.

This chapter describes all the setting options for the display presentation.

Touch the **Settings** button and enter your PIN code.

Follow the path: **Settings** (PIN code 9999) / **Control panel** / **Settings** and the following window will appear:



Illustration 13: Display-> Example: Setting options

Your settings window for setting the time period for the screen saver to appear appears:

Screensaver appears automatically after minutes

1. follow the path in the display:

Settings / Control panel / Settings / Standby to

2. a new window appears when you press the white area next to **Standby after**....:

3. set the desired time - in minutes: a) by tapping **+** or **-** or

b) by sliding the slider to the right or left

4. press **O.K.** to confirm;

→ The setting is accepted.



Illustration 14: Display customization - screen saver

This setting activates the screen saver after the desired time.

The brightness of the display

You can adjust the brightness of the touch display to adapt it to the local conditions.

To set the brightness, proceed as follows:

1. Follow the path: Settings / Control panel / Settings / **Brightness**
2. A new window appears by pressing on the white highlighted area under **Brightness**. 3:
3. set the desired brightness:
 - a) by tapping **+** or **-**
 - or
 - b) by sliding the slider to the right or left
4. press **O.K.** to confirm.
→ The setting is accepted.



Illustration 15: Display customization - Brightness

You can set **the length of the long signal tone** that sounds in the event of a fault (error message) or information message.

To set the duration of the long tone,

1. Follow the path in the control structure:
Settings / Control panel / Settings / **Long tone**
2. a new window appears when you press the white area next to **Long tone**:
3. set the desired time - in seconds:
 - a) by tapping **+** or **-**
 - or
 - b) by sliding the slider to the right or left;
4. press **O.K.** to confirm.
→ The setting is accepted.



Illustration 16: Display customization - Long tone

You can set **the duration of the short signal tone** that sounds in the event of a fault (error message) or information message.

To set the duration of the short tone,

1. Follow the path in the control structure:
Settings / Control panel / Settings / **Short tone**
2. a new window appears when you press the white area next to **Short tone**:
3. set the desired time - in seconds:
 - a) by tapping **+** or **-**
 - or
 - b) by sliding the slider to the right or left
4. press **O.K.** to confirm.
→ The setting is accepted.

You can set **the time interval for the repetition of the signal tone** that sounds in the event of a fault (error message) or information message.

To set the duration of the long tone,

1. Follow the path in the control structure:

Settings / Control panel / Settings / **t Sound repetition**

2. a new window opens by pressing on the white area next to "**t Tone repetition**":

3. set the desired time - in seconds:

a) by tapping + or -

or b) by sliding the slider to the right or left

4. press **O.K.** to confirm.

→ The setting is accepted.

Log out after function

You can set the waiting time after which the touch display should automatically exit the Settings function area if no input is made (Settings log-out).

To set the waiting time, proceed as follows:

1. Follow the path:

Settings / Settings / Control panel / Log out **to**

2. a dialog window appears with the bar display; by tapping + or - you can navigate through the area

3. tap **O.K.** to confirm the selection.

→ The setting is accepted.

Automatic changeover between summer and winter time

For an automatic changeover between summer and winter time, you can set the time zone in which the installation location of the boiler is located.

To set the **time zone**:

1. Follow the path:

Settings (with PIN code) / Control panel / Settings / **Time zone**

2. a window for selecting the desired time zone appears

3. select the time zone;

4. select **O.K.** to confirm;

→ The setting is accepted.



Illustration 17: Display Individualizing time zones

Screensaver

You can change the appearance of the screensaver. You have several options.

To change the screensaver, proceed as follows:

1. Follow the path:

Settings / Control panel / Settings / **Screensaver**

2. a dialog window appears with the options listed. Touch the desired screen saver.

3. press **O.K.** to confirm;

→ The setting is accepted and the desired screen appears.



Examples of screensavers:

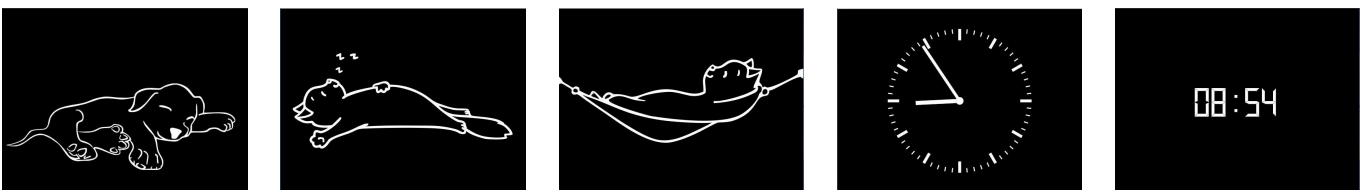

Language

You can also change the desired boiler control language after the boiler has been configured. The languages that are not available are displayed darkened.

To change the language setting, proceed as follows:

1. Follow the path:

Settings / Control panel / Settings / Language

2. A dialog window appears with the flags of the respective countries;

3. Press the flag of the desired language;

→ The language setting is applied

4. if the language setting has been changed, the control panel is automatically restarted;

5. press **O.K.** to confirm the restart of the control panel;

→ The control panel is restarted and the language is adopted after the restart.



Illustration 18: Display Customization Language

Design

You can change the appearance of the touch display to adapt it to the local conditions. You can select the background color of the display: white / black.

This process takes approx. 1 minute.

To change the appearance, proceed as follows:

1. Follow the path:

Settings / Control panel / Settings / **Design**

2. A selection window appears in which you can select the desired setting (**white** or **black**) by touching it.

3. Tap **O.K.** to confirm

4. please wait until the control unit switches off automatically and then switches on again (approx. 1 minute)

→ The setting is accepted.



Illustration 19: Display design selection



Illustration 20: Display with black design

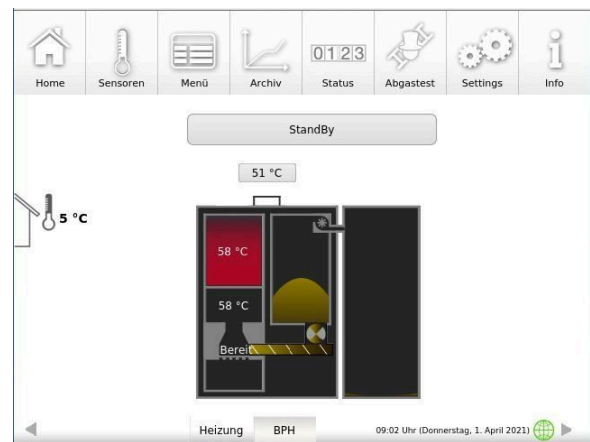

Illustration 21: Display with white design

4.6.2 Locking the boiler - for filling the pellet store



NOTE

Switch off the boiler approx. 1 hour before filling the pellet store. This is done on the user interface with the “Lock boiler” function.

1. in the home view of the boiler, tap **Menu (=Menü)**.

2. on the first menu page, tap on **Locked (= Gesperrt)**



3. the display changes to: **Locked: Yes (= Ja)** and orange:

4. in the home view, “**Boiler locked (= Kessel gesperrt)**”



If the pellet boiler is not in standby mode, it can still be locked. All necessary processes are carried out automatically by the control unit. For the operator of the pellet heating system, the process remains the same as described above.

This blocking function means that pellet delivery is possible under safe conditions. Once the boiler has been locked, it can no longer be started.

Only after release (unlocking), if a heat request is pending, is it possible to start the boiler again. To unlock, carry out the above steps in reverse order.

4.6.3 Exhaust gas test



NOTES on preparatory activities:

Clean the boiler approx. 3 days before the flue gas measurement by the chimney sweep.

The boiler BPH 7/24 und BPH 9/30 has a chimney sweep button in the menu view. The color indicates whether the chimney sweep function is active or not:

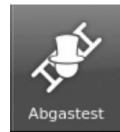

= Function
Flue gas test
is inactive



= Function
Flue gas test
is active

The flue gas test can only be carried out in the following operating states: in *standby*, *ignition* and *combustion*.

For a manual start

1. click on the chimney sweep button;
2. under Flue **Emission test (= Abgastest)**, select: **Immediately (= sofort)**;
3. under **Start**, select: **On (= Ein)**;

The pellet boiler is automatically prepared for the flue gas test. If the boiler was in *standby*, the test can be carried out in approx. 60 minutes.

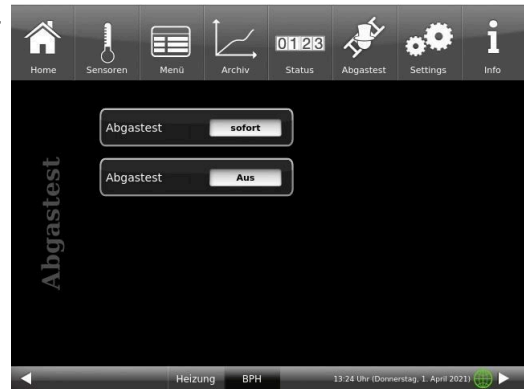

You can cancel a started flue gas test at any time by clicking on **Start: Off**

Do you have an appointment with your chimney sweep to carry out the flue gas measurement? This appointment is also managed by the boiler control unit: the control unit not only prepares the boiler for the specific date and time, but also reminds you 3 or 1 day in advance that the flue gas test appointment is approaching.

To do this:

1. click on the chimney sweep button (is currently white)
2. for **Emission test (=Abgastest)** : **later (= später)** and under **on (= am)** enter the date or under **at (= um)** enter the time
3. for **Auto. start (= Autom.Start): On (= Ein)** so that the boiler starts the preparations automatically.

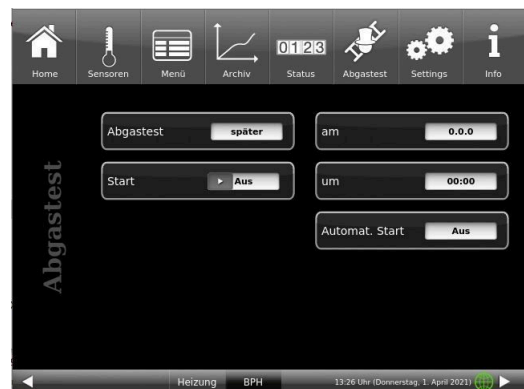

4. To activate the settings for the flue gas test, click on **Start: On (= Ein)**

The activation of the function for preparing for the flue gas test is indicated by the green color of the chimney sweep.



3 or 1 day before your appointment for the flue gas measurement, you will receive a reminder for the flue gas test appointment:



The appointment for the flue gas measurement has been postponed?
-> set the new appointment in exactly the same way as 1 - 4.

Is the chimney sweep late?

-> extend **runtime max (= Laufzeit max)**

If the runtime has expired, the boiler is in normal burn-up mode. The flue gas test can then be started **immediately (= sofort)** as long as the burn-up lasts.





Note

Ensuring heat dissipation

In conjunction with the BRUNNER central heating system (BHZ) or with the BRUNNER extension board Basic, if available also EWP heating circuits, all connected heating circuits are set to heat dissipation to ensure heat dissipation (regardless of whether they are enabled or not).

4.6.4 Selecting or creating new heating programs

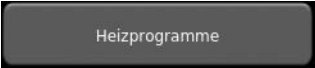

By tapping the Heating circuit button  button or the button from the top menu bar  you can access the Heating programs  button. The following programs are set at the factory:

Program name	Day	Day mode 1		Day mode 2		Day mode 3	
		Day On	Off	On	Off	On	Off
Family	Mon-Thu	5:30	22:00				
	Fri	5:30	23:00				
	Sat	6:30	23:00				
	Sun	7:00	22:00				
Single	Mon-Thu	6:00	8:00				
	Fri	6:00	8:00				
	Sat	7:00	23:30				
	Sun	8:00	22:30				
Seniors	Mon-Sun	5:30	23:00				
New 1							
New 2							
New 3							
Off	The selected heating circuit is deactivated! Frost protection is activated.						

Individual program requests:

You can enter the desired times and names for each heating circuit and for each hot water program.

Defining a heating program

You can enter your own programs for the existing heating circuits on the display.

1. call up the **heating circuit** menu:
 either by clicking on the graphic element of the relevant heating circuit from the home view
 or by clicking on the “Heating” icon in the top menu bar and then on the button for the relevant heating circuit;

2. tap on the **Heating programs** field;
Click on the white field



and select your suitable program from the preset programs. Selection options:

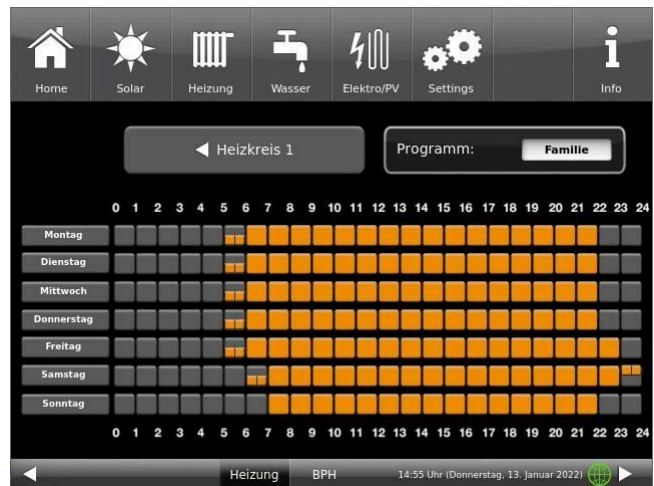

3. to create a new program under **New 1**, **New 2** or **New 3**, tap on the box with the desired day of the week.

You can activate the desired times for each day of the week.

These can also be changed individually by selecting the days of the week. Several days of the week cannot be selected at the same time.

By tapping on the time periods 0-6, 6-12, 12-18 and 18-24, the entire line is highlighted in orange (= heating active) or gray (= heating inactive). Individual boxes can be marked orange or gray by tapping on them.

The factory programs cannot be overwritten.

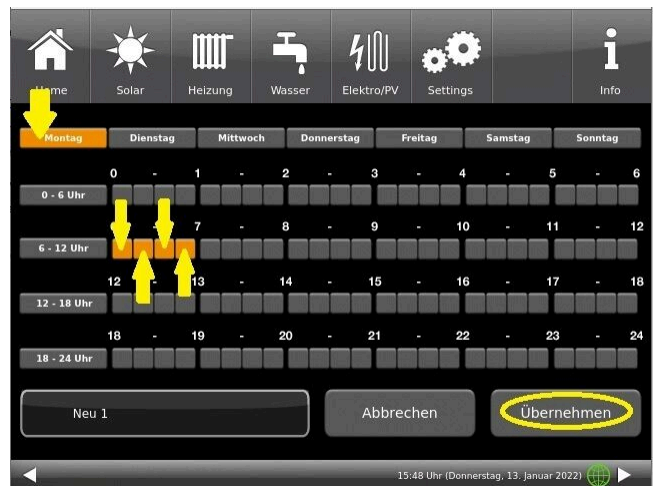
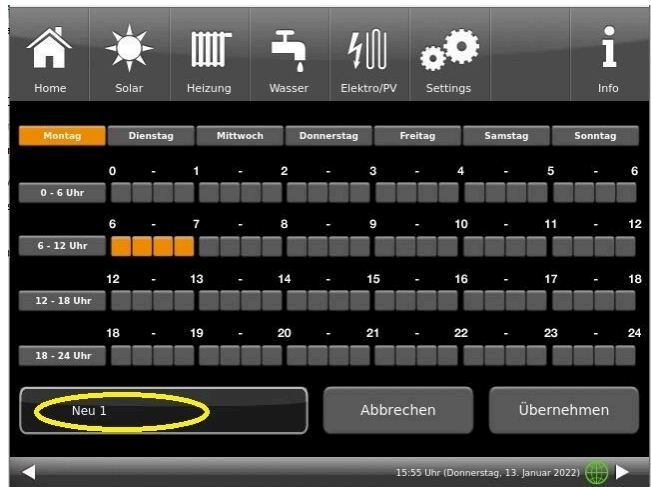

Illustration 22: Example: Monday between 6 and 7 a.m. the heating is on

If you want to change the name of the entered program, tap the button with the previous program name.

A new window with a keyboard appears



Enter the new program name using the keyboard that appears.

To confirm and accept the new program, tap **O.K.**

→ The new program for heating circuit 1 has been saved under a new name.



4.6.5 Setting the program for hot water



You can select an existing program or enter a new program (similar to “Selecting or creating heating programs”)

Tap on the **Water (= Wasser)** button in the top menu bar or on the DHW storage tank button on the home view of the heating system and the button for DHW

programs will appear

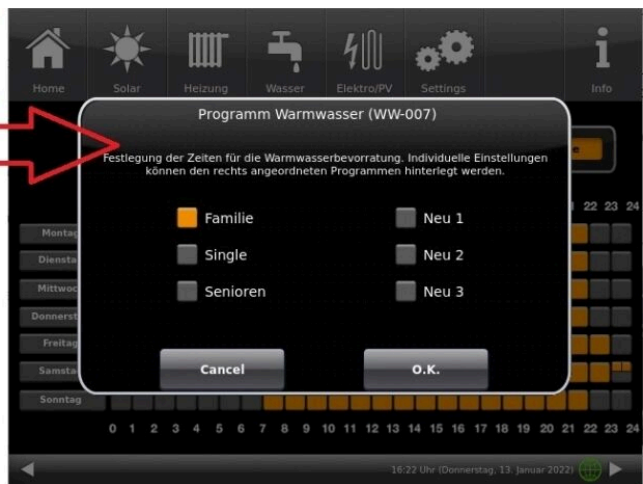
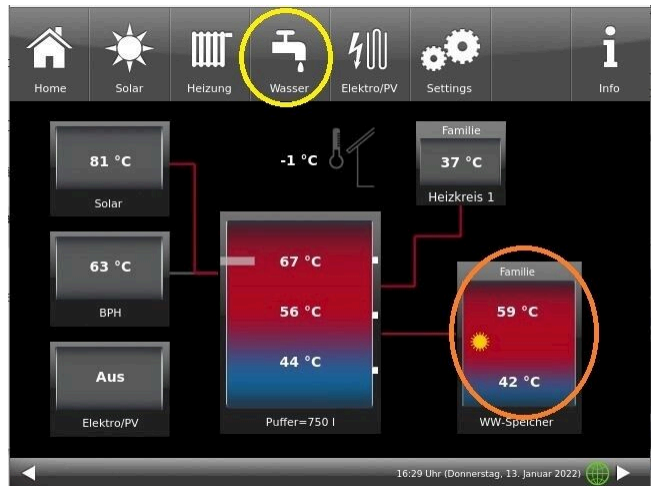

4.6.6 Absence time

If you are not at home for a longer period of time, i.e. you will not have any heating or hot water consumption, you can select the settings for this period so that energy is saved.

During this time, the selected heating circuits or hot water storage tanks will only operate in frost protection mode. In this way, you can not only save a lot of energy, but also protect your system from frost.



The absence program can be interrupted, cancelled or resumed.

The vacation program is shown on the display. The vacation days are displayed and counted down at the same time.

Once the set absence time has elapsed, the system automatically switches back to your program.

1. for this setting, tap:

Heating (= Heizung) button / (= Heizkreis 1) Heating circuit 1 (or the relevant heating circuit) / Absence (= Abwesenheit)

2. tap on the **Absence (= Abwesenheit)** field and enter the number of days you will not be at home.

→ The absence has been accepted and is automatically switched on at the set time and switched off later.

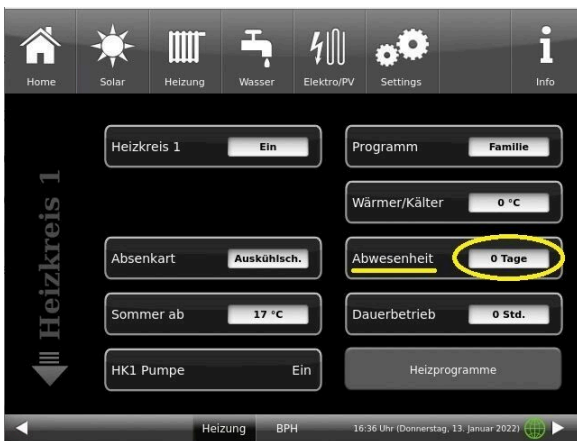
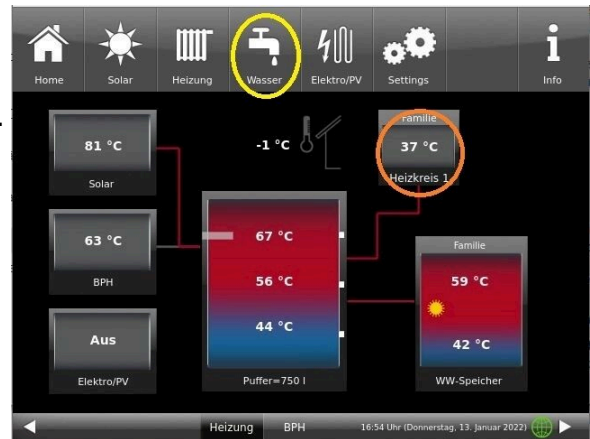

If you have installed a hot water cylinder for hot water preparation, you have the option of setting the absence time.

To do this, tap on the hot water tank graphic (button) in the Home view or click on the **water symbol** in the top menu bar / **Absence (= Abwesenheit)** button. A sliding bar appears, which you can use to enter the days of absence.

Logically, the status display **Off (= Aus)** appears in the header of the hot water tank during the absence time. The remaining active absence time is displayed in the **Water** menu in the **Absence (= Abwesenheit)** button (countdown).

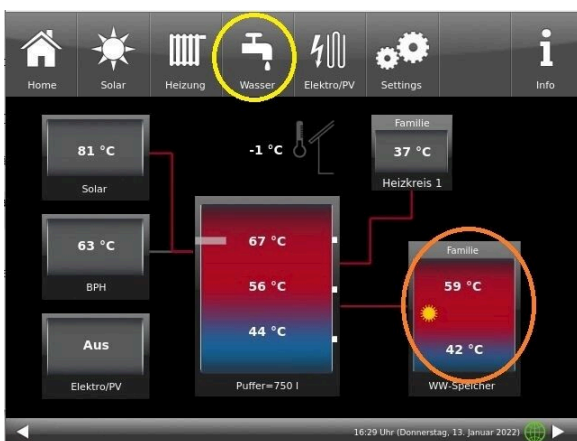

4.6.7 Lowering type

Selection of lowering mode - Reduced mode/Night lowering

For each heating circuit you can choose individual lowering types for reduced mode or night lowering mode:

Cooldown protection	Selection of 'T_outdoor' limit for outdoor temperature, where the mode will change between "Disabled" and "Reduced". This is some kind of Winter/Summer mode switching during night! If this limit is exceeded, the heating circuit will be disabled. Below this limit, the flow temperature is reduced to Night mode level.
Standard	Flow temperature is reduced for Night mode operation. Heating circuit pumps are still running. Parameter: Lowering
Frost protection	The heating circuit is generally disabled at night. Heating circuit pumps are deactivated (Pump 3 (A9) or 4 (A12) off).
Off	No temperature lowering in Night mode

When in Home view, tap on the heating circuit graphic or select the softkey **Heating** and then select the softkey of the relevant heating circuit.

Lowering type is used to determine the behavior of heating circuits during defined "inactive" periods. *Standard* lowering type is used to decrease the normal supply temperature of heating circuits during defined "inactive" periods by 'T_lowering' parameter value.

If **Frost protection** is selected, the heating circuit pumps are switched off during "inactive" periods. Just when **Frost protection from** value is exceeded, the pumps are activated again. Heating circuit flow temperature is now controlled without individual heating characteristics. If the temperature exceeds **Frost protection from + dT frost prot.** value, the pumps are switched off

Die Absenkart Auskühlschutz verhält sich eigentlich wie der Frostschutz, mit dem Unterschied, dass hier als Temperaturschwelle 5°C gilt und die Heizkreisvorlauftemperaturen entsprechend der Heizkennlinien geregelt werden.

Parameter	Value (min, max, default)	Description
Lowering mode	Cooldown protection, Frost protection, Standard	Determines the type of flow temperature reduction.
Heating system		Determines the choice of heating curve.
T_lowering	0°C, 100°C, 5°C	FL temperature is reduced by this value during "inactive" periods.
T_outdoor	-20°C, 50°C, 5°C	Threshold value to change between "reduced" mode and "disabled" mode.

4.6.8 Summer/Winter switching

The user can adapt the settings for switching between the Winter and Summer operation modes. For this, tap the **Heating** button from the upper menu bar or the graphic of a specific heating circuit. Then tap the **Summer from** button. Using the sliding bar, set the desired switching temperature.

If the outdoor temperature exceeds the 'Summer from' switching threshold, the relevant heating circuit pumps (A9 or A12) are deactivated. For every heating circuit you can select an individual value for Summer/Winter switching. There is also an option: to select permanent Summer or permanent Winter operation mode for heating circuits (Parameter, range: *permanent Summer*, 10, ...40, *permanent Winter*).

If the outdoor temperature is lower than selected by more than 1°C, Winter mode will be switched on again.

4.6.9 Permanent

If you want to switch the heating circuit to permanent operation for a desired time:

1. In Home view, tap on the graphic of a **Heating circuit (= Heizkreis)**;
2. A window with settings for **Permanent (= Dauerbetrieb)** operation will appear. Using the sliding bar, you can set the hours.

In this time the heating will be active.

After these hours will pass, the heating returns to the existing heating program.



4.6.10 Heating circuit frost protection

To set the frost protection function, follow the path: Settings (+ PIN entry) / relevant button for heating circuit and / or domestic water / parameter settings for frost protection (... frost ...)

The heating circuit frost protection has priority over all selected settings. As soon as the predefined outdoor temperature threshold in parameter *Frost protection from* (basic setting: 1°C) is reached, the inactive circulation pumps of heating circuits (e.g. HC pump off, because minimal or maximal flow temperatures are exceeded; heating circuit configuration is "OFF") will be automatically activated with a flow temperature value of Tmin Buffer. If the circulation pumps are already active, this function has no effect.

4.6.11 Disinfection

NOTE: Disinfection relates to the connected hot water cylinder.

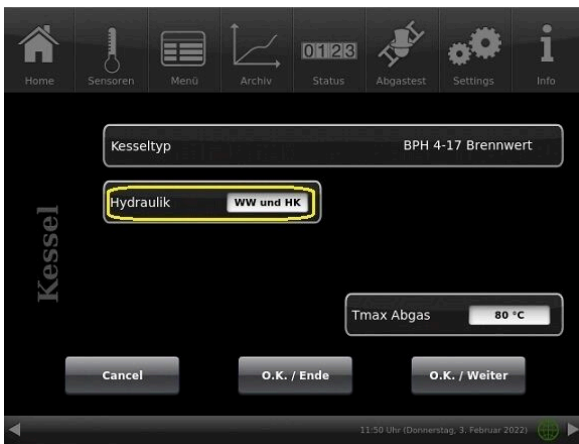

Illustration 23: Setting in the configuration

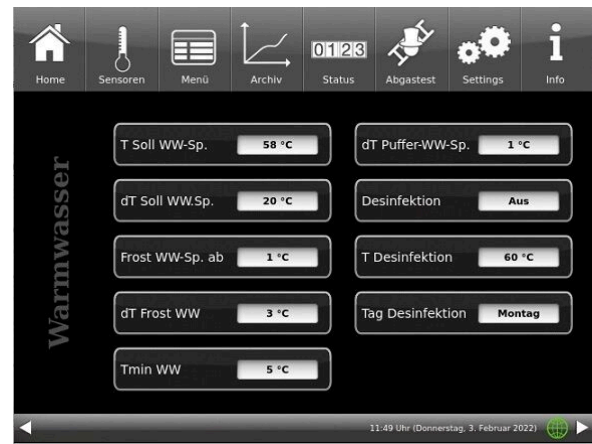
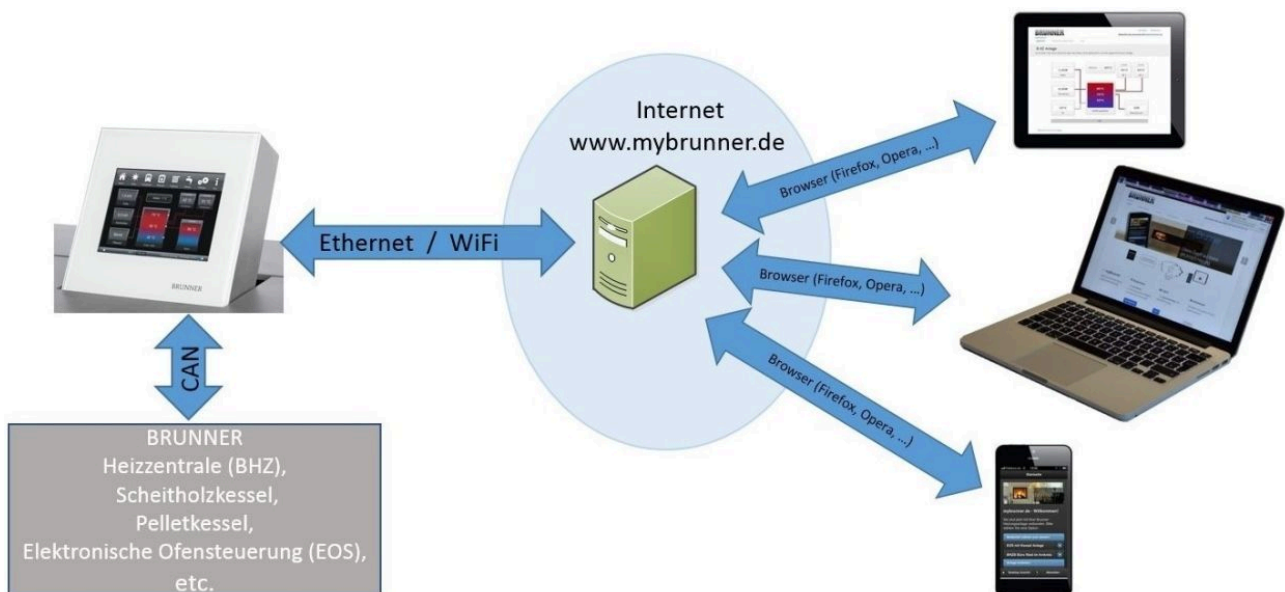

Illustration 24: Buttons for disinfection

To be able to carry out the actions for thermal disinfection automatically, make the following presets: **T Disinfection (= T Desinfektion)** (temperature of disinfection); Execution time: **Day Disinfection (= Tag Desinfektion)**; Time Disinfection (= Uhrzeit Desinf.); Duration Disinfection (= Dauer Desinf.).

4.7 Remote access via myBRUNNER

4.7.1 Preconditions and instructions



Preconditions for on-line access to your BRUNNER heating

1. You have a BRUNNER heating system with Touch Display;
2. The Touch Display software update status must be Release 4.0 (from December 2013) or higher;
3. A connection between Touch Display and Internet access point (a router) in the building is required. A flat rate (broadband) Internet connection is recommended for reasonable operation.
4. PC/Tablet/Smartphone with access to your personal e-mail account.
5. PC/Tablet/Smartphone with Internet access via web browser to **www.mybrunner.de**

Instructions for registration

Each control panel (Touch Display) can be registered once. You can assign only one e-mail address for a control panel. If the user wants to use a different e-mail address, he/she must delete the registration entry and perform the complete registration process once again (for this, use the **Delete registration** button). The same process, as in the case of changing user.

If a user has many Touch Displays for a heating system, every Touch Display can be connected with myBRUNNER. Every control panel can have a different e-mail address assigned.

With mobile devices such as tablets or smartphones, the embedded browser cannot be used with older Android variants; therefore you should load a current browser like Firefox, Opera, Chrome.

If it is not possible to log in, please check:

1. if the control panel is in Setup mode (Login active)? Before you log in, perform Settings logout function. (Softkeys: **Settings / Control panel / Settings logout**).
2. if the system clock of the control panel is set? The setting must be exact as possible. The same applies to days of week, time zones and year (see: User Guide / sect. "Individual settings" / sect. "Display customization")
3. if the system or control panel is now running an update sequence? Please wait until finished and try again.

Instructions for enabling Service access

The access to service functions can be enabled exclusively for heating contractors or BRUNNER service technicians. Mutual access for both categories of servicemen is not possible.

4.7.2 Registration

1. Start the first registration



- 1.1. Go to **www.mybrunner.de**;
- 1.2 Click the button **Register now**;

The screenshot shows the mybrunner.de website with a navigation menu (START, REGISTRIEREN, LOG-IN, INFORMIEREN, KONTAKT, FAQ) and a main banner for 'myBrunner Online-Zugriff auf meine BRUNNER Heizung'. Below the banner is a diagram illustrating the connection between a control panel, a router (VLAN/LAN), and the mybrunner.de server. The main content area features four columns: 'myBrunner' (with a link to the portal), 'Registrieren' (for new users), 'Log-in' (for registered users), and 'Informieren' (for service access). A yellow arrow points to the 'Jetzt registrieren' button in the 'Registrieren' column. The footer contains contact information for Brunner GmbH, including address, phone, fax, and email, as well as a social media link to Facebook.

This window/box appears:



1.3 Enter your contact details (Name, Address); the fields with * are mandatory fields;

1.4 When finished, click **next**;

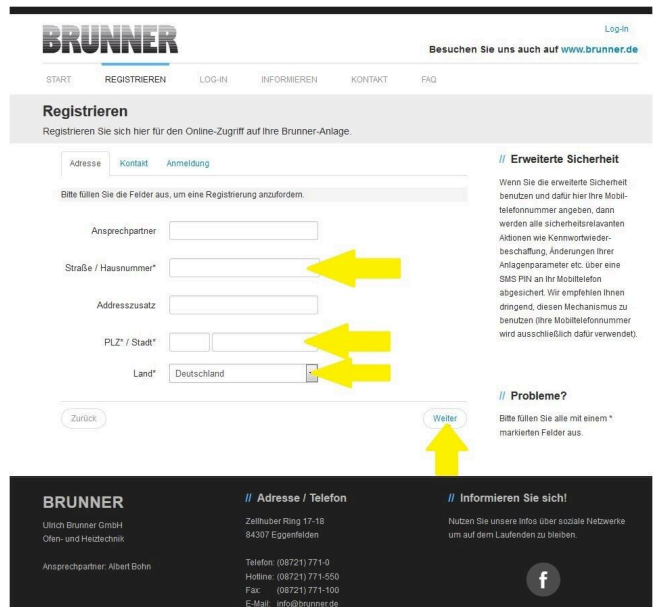

1.5 Enter a valid e-mail address;



The e-mail address is at the same time your login name!!!

1.6 Optionally - for increased security - you can enter your mobile phone number.

1.7. Click **next** to complete your entries on this page.

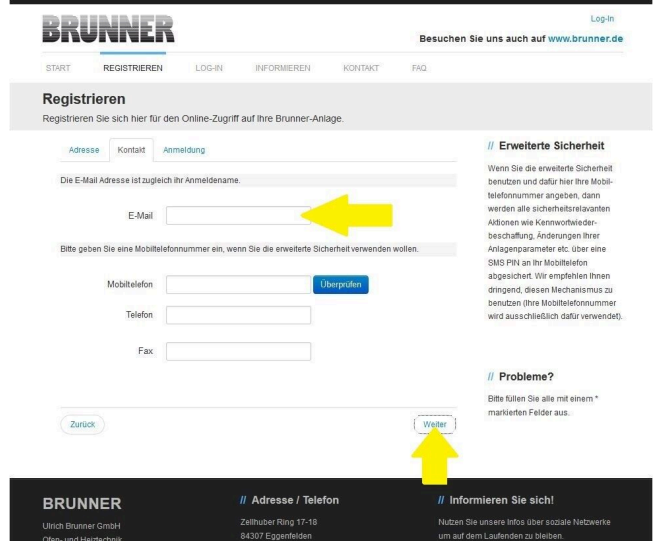

1.8 Enter a password;



The password must be at least 8 characters long!!
Please remember this password, as it is used to access your system.
All fields are mandatory!

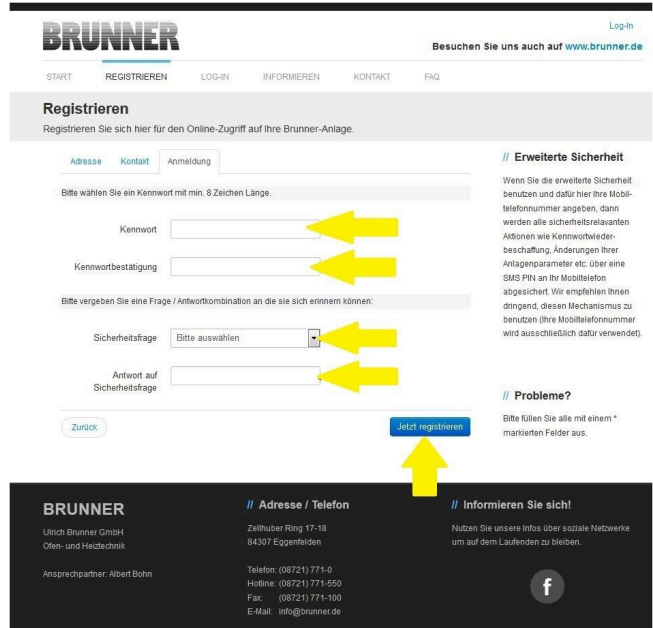

1.9 Select a security question. You can choose between: Your favorite football team? Your favorite travel destination? Your Mother's maiden name? Your favorite movie? Your favorite book? Your favorite pet? Name of your first girlfriend (or boyfriend)? Name of your first pet? Your meaningful year number? Your favorite restaurant?

Please enter a valid answer, which will be used later for confirmation.

1.10 Click the button **Register now** when finished.



1.11 The details of your registration will be shown:

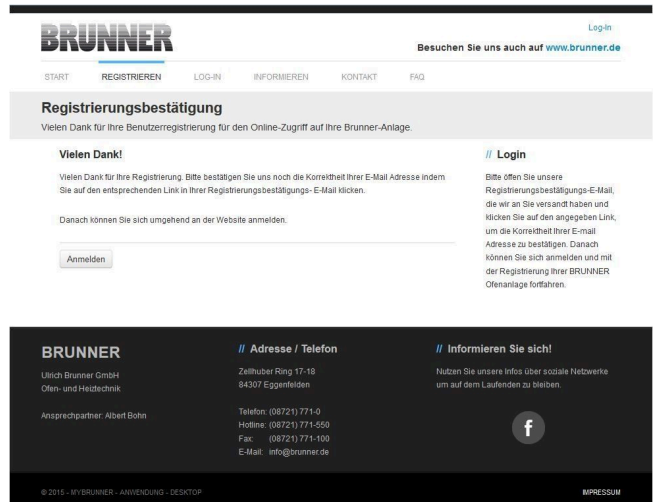

2. E-mail box - Confirmation of registration



2.1 Open the e-mail from “**websystem**” and subject line: “**Brunner Zentrale Benutzerverwaltung: Registrierungsbestätigung**” (Brunner Central User Administration: Confirmation of registration)

2.2 Click on the link;

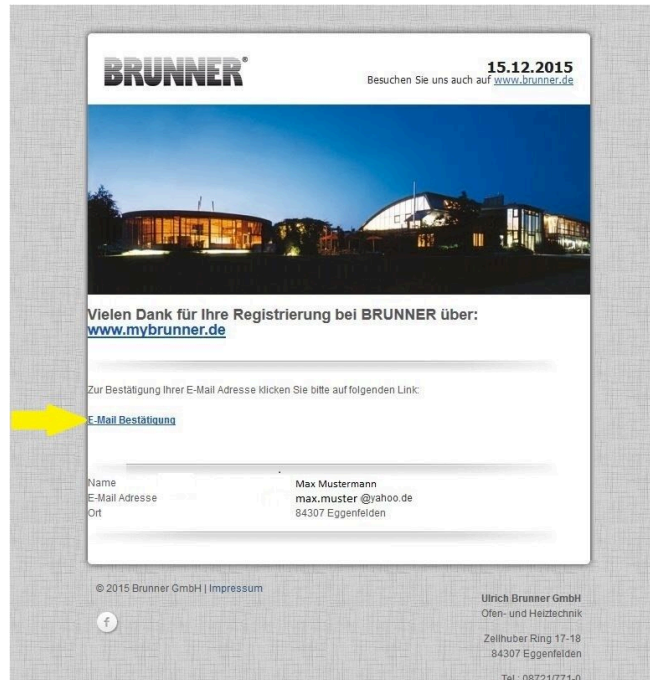

3. Login



3.1 Click **Login**

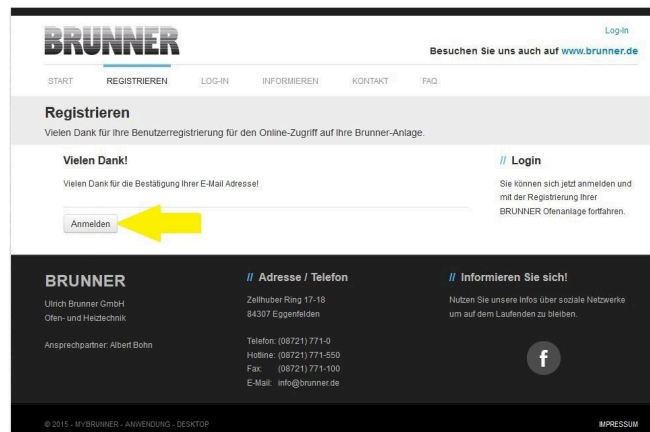



3.2. At Login name enter your email address

3.3 Enter your **password** (entered beforehand and repeat - see 1.8)

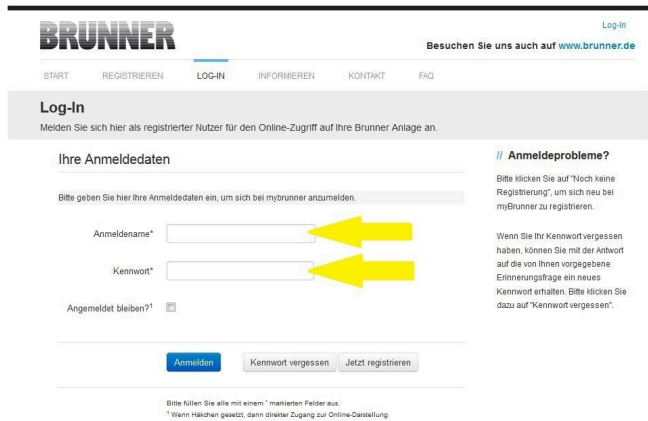

3.4 The control unit (touch display) of the Brunner system must be registered. To do this, click the New Control **Neues Bedienteil**.

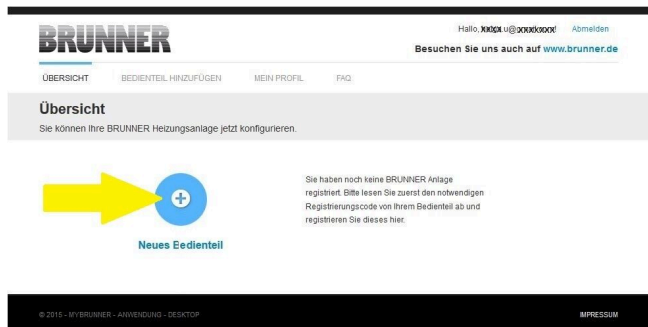

NOTE:

If you had previously registered a different control unit, click the Add another control unit button **Weiteres Bedienteil hinzufügen**.

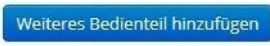

4. Activate the network

4.A. Connected via network cable (Touchdisplay 2.0 and/or Touchdisplay 3.0)

To see if the Internet connection is available on the Touch Display, look at the icon (globe) in the lower right corner of the Touch Display. If the Internet connection is available (network active), the globe color is gray.

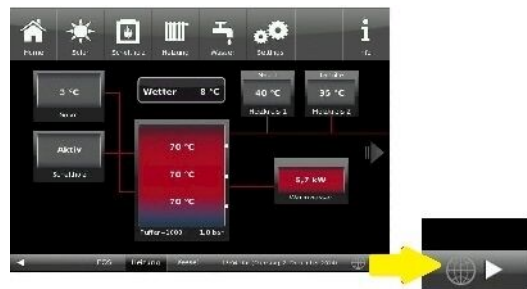

Illustration 25: Internet connection available (gray globe)



- 4.1 Click in the upper menu bar on **Settings**
- 4.2 Enter the PIN Code **9999**
- 4.3 Click on the control display button **Bedienteil**
- 4.4 Click on the **myBrunner** button



- 4.5 Navigate down with the arrow key:



4.B. Connected via WLAN (Touchdisplay 3.0)

To see whether you have an internet connection on the touch display, look at the graphic (globe) at the bottom right of the touch display. If there is an internet connection (network active) the globe is gray.

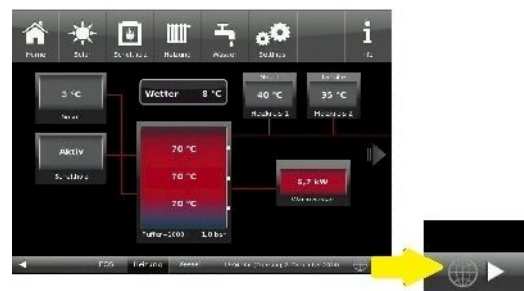

Illustration 26: Internet connection (gray earth globe)

4.1 Click in the upper menu bar on **Settings**

4.2 Enter the PIN-Code **9999**

4.3 Click on the display button **Bedienteil**

4.4 Click on the display button **myBrunner**



4.5 Navigate down with the arrow key:





4.6 Set up WLAN:
- Select WLAN name.

if the name you are looking for is not available for the WLAN name, click on search **Suche**

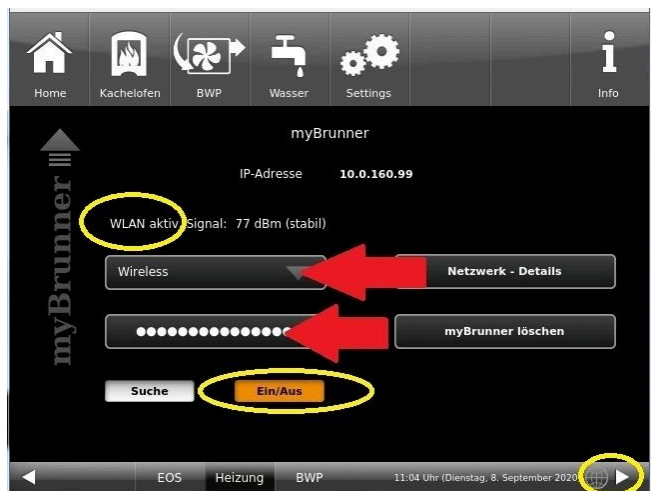

4.7 Enter WLAN-Pass-
word and click O.K.



4.8 Navigate up with the arrow key





4.9 Click:



5. Set up mybrunner on Touch Display



5.1 Click:



5.2 Terms and conditions appear.

5.3 Read the terms and conditions. Please keep the arrow pressed to scroll. When the arrow is pressed, it turns orange.

5.4 Accept the terms and conditions at the end of the text by accepting **Akzeptieren**. (To do this, scroll the entire text to the end. Only then is the Accept button active).

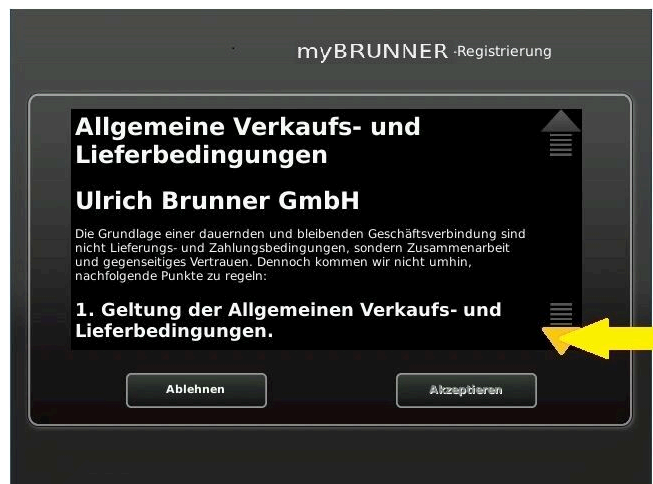

6. Establish registration code



6. The following screen will appear automatically to establish the registration code of the Touch Display (control panel). This number is displayed for 2 hours.

You should use this registration code for your control unit to continue the registration on the PC.



7. Registration of your Brunner system



7.1 The control unit (touch display) of the Brunner system must be registered. To do this, click the New Control Unit button **Neues Bedienteil**.

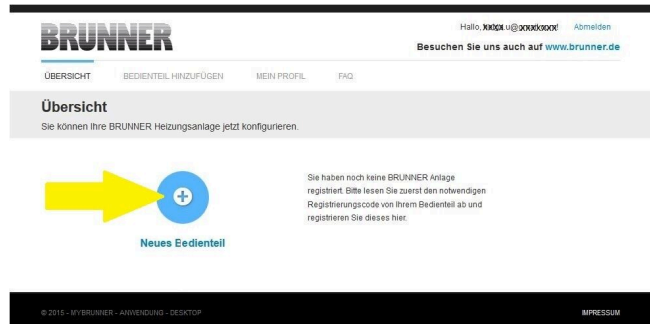

NOTE:

If you had previously registered a different control unit, click the Add another control unit button here. **Weiteres Bedienteil hinzufügen**.

Weiteres Bedienteil hinzufügen



7.2 Im Feld **Registrierungscode** die Registrierungsnummer vom Touchdisplay eingeben

7.3 In the system name field **Anlagenname**, enter your preferred designation for the system.

7.4 Finally click on registration **Registrieren**.

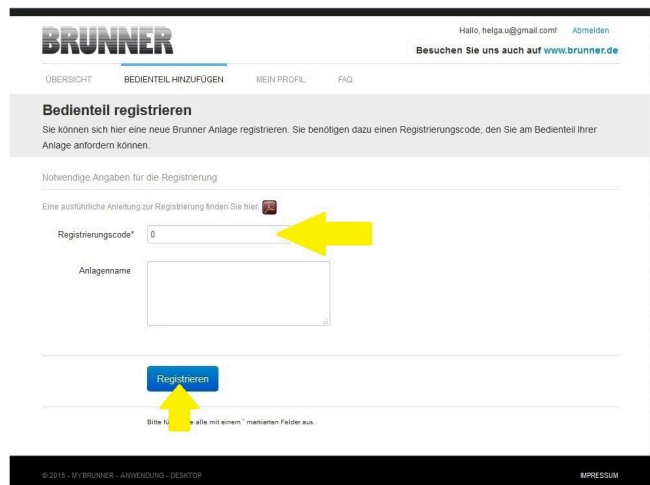

8. Complete registration on Touch Display



8.1 Confirm the message about successful registration with **O.K.**

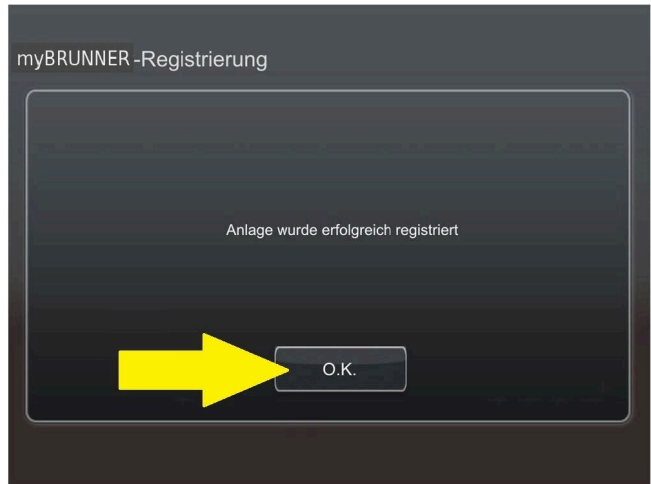

8.2 Exit settings (with OK)



9. On-line access to the control panel from your PC, tablet or smartphone



On your mobile device (notebook, tablet, smartphone etc.) you will see the system overview:

Now you can control all the functions of your system from your mobile device via mybrunner.de. The Parameter sections under Settings are excluded.

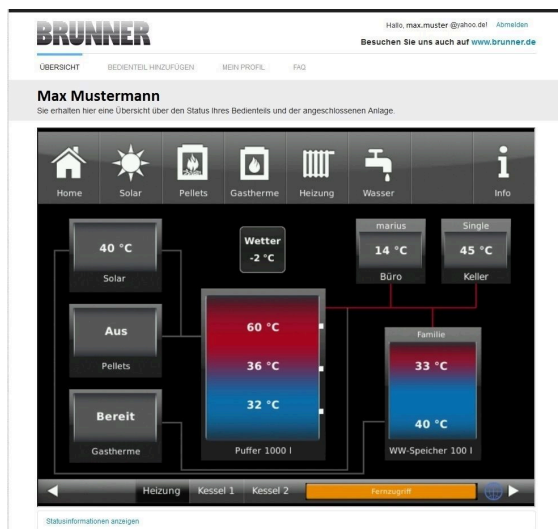



During remote access you will see the following identical screen on the Touch Display:

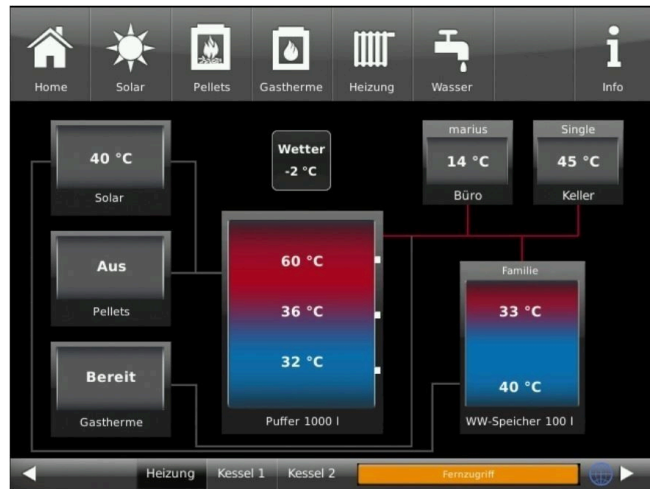

→ The registration process is complete.

4.7.3 Logging in

On your PC, tablet or smartphone:



1.1 Open **www.mybrunner.de** in your browser

1.2 Enter your valid login name (= your e-mail address entered during registration)

1.3 Enter your password/**Kennwort** (as entered during registration)

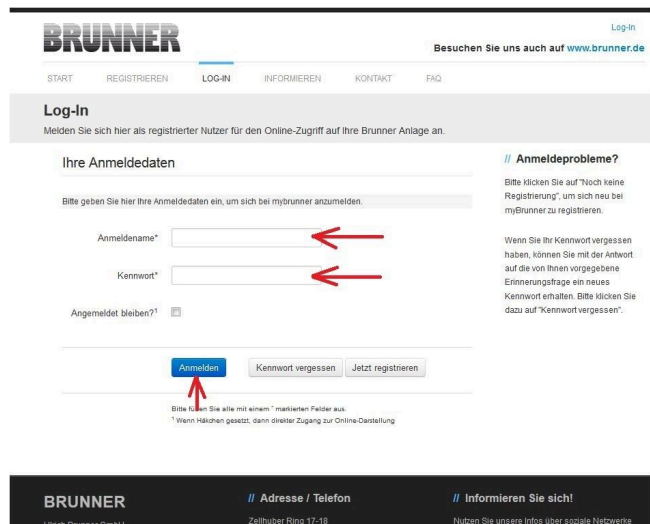

If you have forgotten your password, you can use the **Kennwort vergessen** (forgotten password) button. Here you will be asked to enter your e-mail address and the answer to your selected security question (as displayed above the answer field); Click on **Kennwort anfordern** (request new password) and you will receive an e-mail with a new password, which must be entered on the Login page at mybrunner.de, in the “Kennwort” field.



If you want to change your password again, or change your contact data, or apply extended security settings, please go to **Mein Profil** (My Profile).

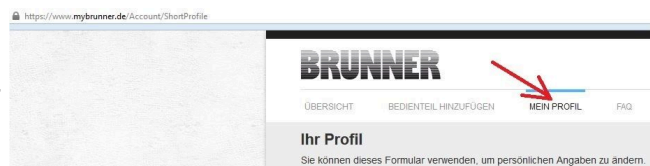



The current overview of your system will appear on the screen of your PC, notebook, tablet or smartphone.

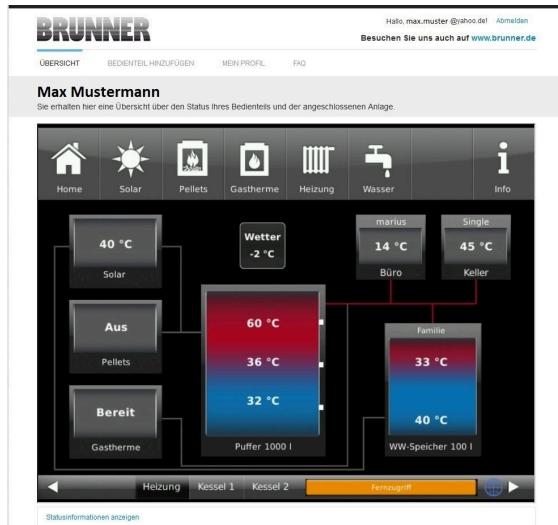

On the Touch Display of your BRUNNER system



To see the myBRUNNER status click: **Settings + PIN-Code (9999) / Bedienteil(=control panel)/ my-BRUNNER**



When the control panel is in remote control mode, the following will be shown on the Touch Display of your system: orange bar with text **Fernzugriff** (Remote access).

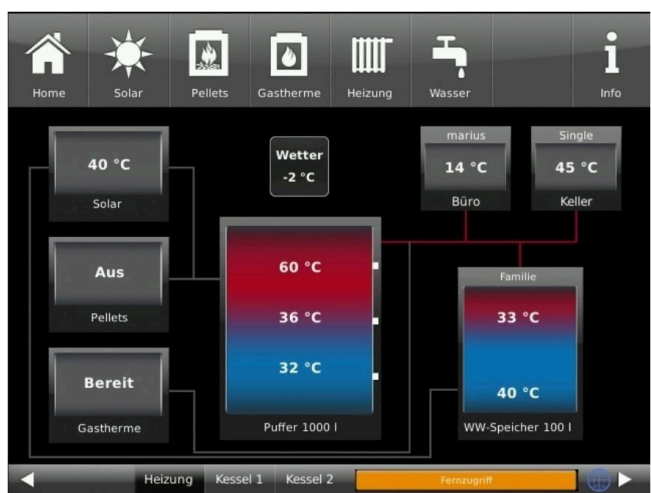



NOTE

The heating system can be controlled only from one device! You can use alternatively: the Touch Display on the system or the overview on your mobile device.

NOTE:

Setting or modification of parameters under **Settings** is not possible via remote access. Exception from this rule is the enabled access for the heating contractor or BRUNNER technicians.

4.7.4 Enabling for Service access

To enable Service access for BRUNNER technicians or a heating contractor, the owner of the system must approve it first. This is done using a fixed Service PIN Code, which is defined in the User account.



1. Log in at **www.mybrunner.de**
(see Logging in section above)

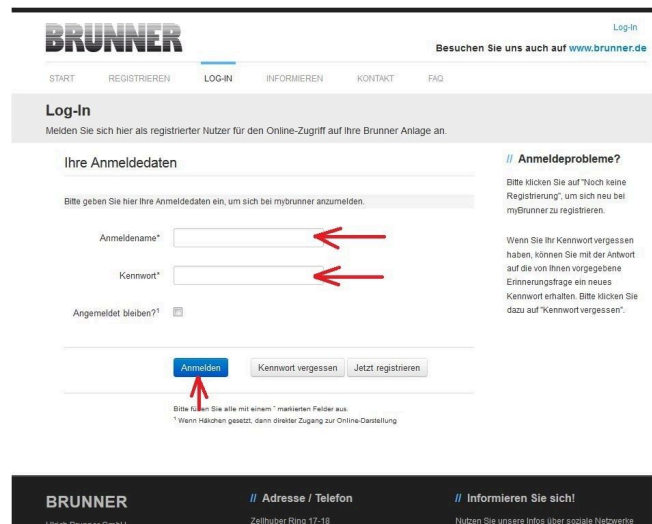



2. Click onto **Grant access to control panel**



3. You can enter the BRUNNER service code or the code of your tradesman.
The BRUNNER service code = 293068.

Enter this 6-digit numeric PIN code in the first field (PIN) and in the second field (purpose of release) please write your family name and location of the system.

The system operator can revoke the tradesman or BRUNNER service's access to the system at any time.

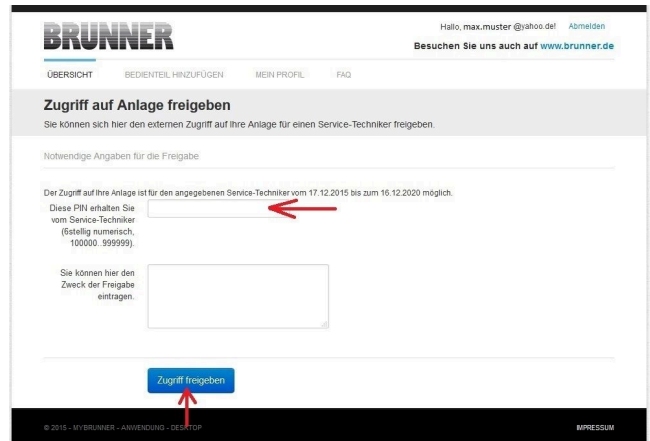
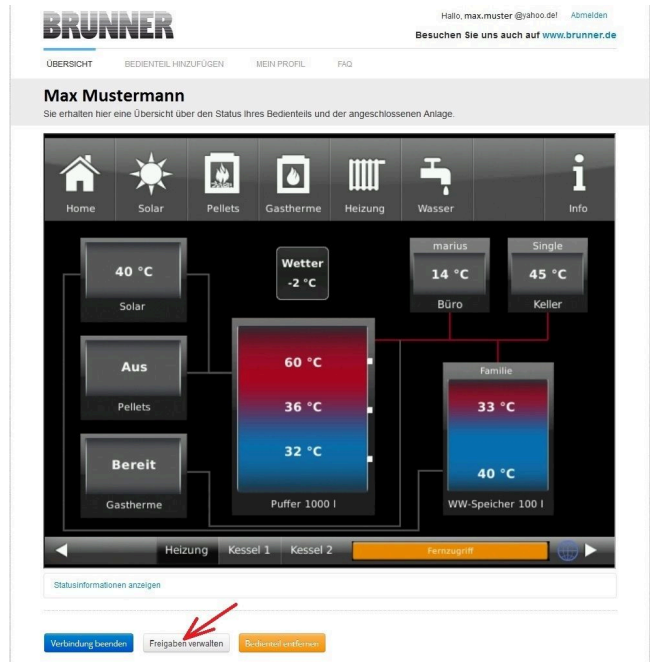



When access is granted, the following message is displayed:

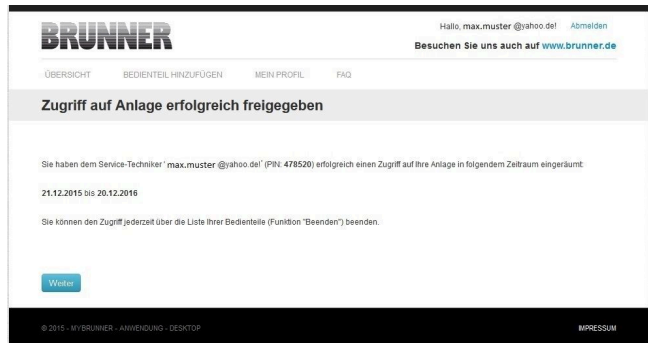

When a contractor has access to your system via myBRUNNER link, you'll see the following on the Touch Display:

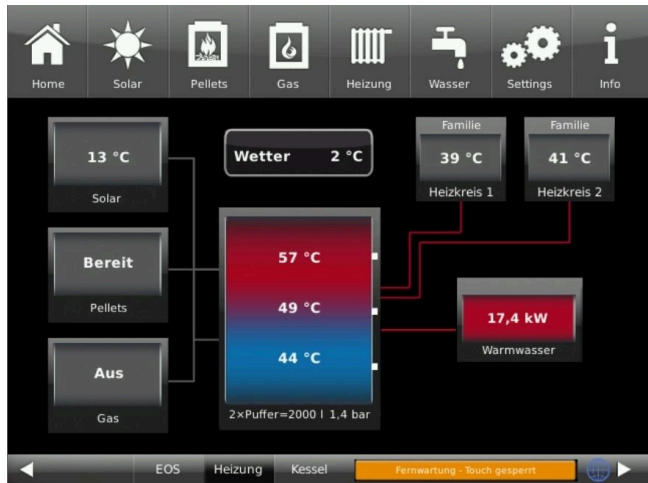

4.7.5 Connect keypads to the Internet

Operating principle myBRUNNER:

For remote access to the personal heating system via the internet (myBRUNNER), the BRUNNER touch display must be connected to the internet access of the building. There are different options and a wide range of peripheral devices for this purpose.



Network cable (Touch 2.0 and 3.0)

The easiest and most safe solution. A connection between the touch display and internet access in the building (router) via a network cable (terms: patch cable, Ethernet, LAN).



4.7.5.1 Activate WLAN

1. Click in the upper menu bar on **Settings**
2. Enter the PIN-Code **9999**
3. Click on the display button **Bedienteil**
4. Click on the display button **myBRUNNER**



5. A dialog window/box appears:



6. Set up WLAN :

6.1. Choose WLAN-Name *

Attention:

- **Ein/Aus** On/Off must be orange
- Check display indication **“WLAN aktiv”**
- Earth globe: gray

*if the name you are looking for is not available for the WLAN name, click on search **Suche**

6.2. Enter WLAN-pasword



4.7.6 Brunner App

The myBRUNNER App makes it easier to access the heating system with smartphones or tablets.

Operation is very easy and self-explanatory. The orientation on the home screen is vertical. The presentation does not go along - but that is set intentionally.

The user can choose from three buttons

- “Login” for login and logout,
- a brief introduction to the functionality of the application software and a contact,
- support- interface for all questions and suggestions about the app.

The fourth button is initially gray when you start the software. Only after entering the user name and the password, it is activated and allows access to the heating control. The customer selects the registered operating unit and makes the desired settings. To leave the view, just click on the “back” button on the mobile device or on the “operating control unit ” on the top left.

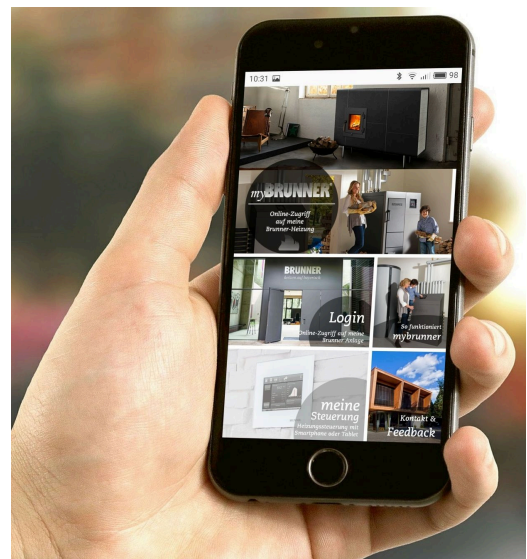

Account settings or registration of control panels can not be done with the app. Account settings or registration of control panels can not be done with the app. Both activities are only possible via a browser via my-brunner.de.

4.7.7 Network adverts



Display with a myBRUNNER connection



Display for an existing network connection, whether WLAN or LAN.



Display with a myBRUNNER-local connection

No globe

No network

4.7.8 Synchronisation with network

Wenn myBRUNNER eingerichtet ist, wird die Uhrzeit mit dem Netzwerk automatisch abgeglichen.

If you do not want to have the time synchronization with the network, deactivation is possible. For this:

1. Click on the time in the lower bar
2. A dialog box appears where you click **Network time- synchronization**;
3. the network time synchronization is deactivated;
4. You can now enter the desired time;
5. then click on **Time / Date**;
→ the time and date are displayed in the lower bar according to your setting or on the clock (digital or analog clock) selected as the screen saver.

The disabled time alignment is displayed with a gray box.



The adjustment of the time or date with the BRUNNER network can be activated at any time.

4.8 Data protection declaration of Ulrich Brunner GmbH

Notes on protecting your personal data

Ulrich Brunner GmbH always endeavors to save and process only the personal data that are necessary and indispensable or that are required to be stored and processed by law.

We strictly adhere to the requirements of the General Data Protection Regulation (GDPR) and the Federal Data Protection Act (BDSG and BDSG new).

We do not pass on personal data to third parties; unless we are required to do so by law or by court order.

Persons under the age of 18 should only transfer personal data to us with the consent of their legal guardians. If there is reason for a complaint, it can be addressed to the responsible state authority.

The required contact details can be found on the website: <https://www.lida.bayern.de>. If other sources of information or services (websites, apps, etc.) from Ulrich Brunner GmbH are used, the data protection declarations listed also apply.

Purpose of data processing

We only collect, store and process personal data for the express or implicitly agreed purpose. These are e.g. Address data for processing an information request, or for making offers, invoicing etc. or bank data for processing payment transactions. Without an independent declaration of consent, this data is not e.g. used to send as newsletter or similar purpose.

Saving and deleting

We only store personal data for as long as is necessary to fulfill the agreed purpose or as required by law. If the agreed purpose is fulfilled or there is no longer a legal basis for storage, this data will be deleted as far as possible. If deletion is not technically possible, the data will be marked in such a way that further processing is impossible.

Deletion requests, requests for information, requests for changes or revocation of a declaration of consent can be directed at any time to the data protection officer of Ulrich Brunner GmbH.

Responsible for data processing

Ulrich Brunner GmbH
Zellhuber Ring 17-18
D-84307 Eggenfelden
E-Mail: info@brunner.de
Tel.: 08721/771-0

You can contact the data protection officer under: datenschutzbeauftragter@brunner.de.

5 Information and error messages

5.1 List of error codes and rectification

Error code	Short text on the display	Description, causes	Note to the operator
PF002	External heat operation (= Fremdwärmebetrieb)	ST50 Block heat request. The heat request is blocked. The ST50 input is closed.	Unblock the external heat request.
PF011	Ignition error (= Zündfehler)	Ignition failed The ignition has failed; the time period for successful ignition has been exceeded.	Check whether sufficient pellets are available. Contact a specialist company.
PF014	O2 too high (= O2 zu hoch)	Lambda alarm The lambda value or oxygen content in the flue gases is too high. Combustion is not optimally controlled.	Calibrate the lambda sensor manually (path: Settings / System / Relay test / Cal. lambda / Manual calib.)
PF016	Exhaust gas temp. too high (= Abgastemp. zu hoch)	Exhaust gas temperature is too high: The temperature of the exhaust gas is too high;	Please clean the boiler. Contact a specialist company if necessary.
PF017	Flue gas temp. too high (= Abgastemp. zu hoch)	Flue gas temperature too high (output throttling) The flue gas temperature is too high. The boiler output must be throttled.	Please clean the boiler. Contact a specialist company if necessary.
PF021	Heat dissipation! (= Wärmeabfuhr!)	Heat dissipation because the boiler temperature is too high.	If this message occurs frequently, contact a specialist company.
PF101	STB has tripped! (= STB hat angesprochen !)	The safety temperature limiter(STB) has been triggered because the boiler temperature is too high.	Wait until the boiler temperature has fallen below 90°C; reset the STB button (STB button position, see "Overview of components"); If the message repeats, contact a specialist company.
PF102	EMERGENCY OFF (= NOT AUS)	ST3 Emergency stop Emergency stop was actuated externally.	Check why the emergency stop button was pressed and rectify the cause. Acknowledge the emergency stop.
PF121	Lambda sensor fault! (= Störung Lambda-sonde!)	Lambda fault There is a fault in the functioning of the lambda sensor. Emergency program intervenes.	Contact a specialist garage.
PF122	Calibration not possible (= Kalibrierung nicht möglich)	Lambda calibration not possible Calibration of the lambda sensor is not possible because the exhaust gas temperature is too high.	Wait until the exhaust gas temperature has dropped and repeat the process. Contact a specialist company if necessary.
PF123	Lambda cal. error (= Lambda Kal. Fehler)	Lambda calibration was interrupted Automatic calibration was interrupted. Calibration of the lambda sensor is not possible because the oxygen content is fluctuating too much.	If necessary, clean the lambda sensor and repeat the calibration. (see service manual). If the error message appears again, contact a specialist garage.

Error code	Short text on the display	Description, causes	Note to the operator
PF124	Lambda cal. error (= Lambda Kal. Fehler)	Lambda calibration was interrupted The manual calibration of the lambda sensor was interrupted. There are excessive oxygen fluctuations in the exhaust gases.	If necessary, clean the lambda sensor and repeat the calibration (see service manual). If the error message appears again, contact a specialist garage.
PF125	Lambda cal. value incorrect (= Lambda Kal. Wert falsch)	Calibration value outside tolerance The calibration value of the lambda sensor is outside the tolerance.	If necessary, clean the lambda sensor and repeat calibration (see service manual). If the error message appears again, contact a specialist garage
PF126	Lambda stop (= Lambdastopp)	Lambda stop has occurred several times during normal operation A lambda stop has occurred several times (at least 3 times) during normal operation.	Contact the specialist company.
PF131	Boiler sensor defective! (= Kessel Fühler defekt!)	ST 34 Boiler sensor short circuit The sensor on the boiler (ST34) or its cables have a short circuit.	Contact a specialist company.
PF132	Boiler sensor defective! (= Kessel Fühler defekt!)	ST34 boiler sensor break The boiler temperature is no longer measured. The ST34 sensor on the boiler or lines are interrupted.	Contact a specialist company.
PF141	Flue gas sensor defective! (= Rauchgas Fühler defekt!)	ST31 Flue gas sensor polarity reversal The flue gas temperature can no longer be measured. The connection cable of the flue gas sensor ST31 has reversed polarity.	Contact a specialist company.
PF142	Flue gas sensor defective! (= Rauchgas Fühler defekt!)	ST31 flue gas sensor broken The temperature of the flue gases is not measured. The ST31 flue gas sensor or its cables have broken. The sensor is defective.	Contact a specialist company.
PF171	Buffer sensor bottom defective! (= Puffer Fühl. unten defekt!)	Buffersensor short circuit The bottom buffer sensor ST35 or lines have a short circuit.	Contact a specialist company.
PF172	Buffer sensor bottom defective! (= Puffer Fühl. unten defekt!)	Buffersensor break The bottom buffer sensor ST35 or lines are interrupted.	Contact a specialist company.
PF173	Buffer sensor top defective! (= Puffer Fühl. oben defekt!)	Buffersensor short circuit The top buffer sensor ST 36 or its cables have a short circuit.	Contact a specialist company.
PF 174	Buffer sensor top defective! (= Puffer Fühl. oben defekt!)	Buffersensor break The upper buffer sensor ST36 or lines are interrupted.	Contact a specialist company.
PF 175	Boiler sensor defective! (= Boiler Fühler defekt!)	Boilersensor short circuit The boiler sensor ST37 or pipes have a short circuit.	Contact a specialist company.

Error code	Short text on the display	Description, causes	Note to the operator
PF 176	Boiler sensor defective! (= Boiler Fühler defekt!)	Boilersensor break The boiler sensor ST37 or lines are interrupted.	Contact a specialist company.
PF177	Buffer sens. center defective! (= Puffer Fühl. Mitte defekt!)	Buffersensor short circuit The buffer center sensor ST33 or the cables have a short circuit.	Contact a specialist company.
PF178	Buffer sensor. center defective! (= Puffer Fühl. Mitte defekt!)	Buffer sensor break The buffer center sensor ST33 or its lines are interrupted.	Contact a specialist company.
PF181	HK1 sensor defective! (= HK1 Fühler defekt!)	Heating circuit sensor short circuit Heating circuit sensor ST30 or the cables have a short circuit.	Contact a specialist company.
PF182	HK1 sensor defective! (= HK1 Fühler defekt!)	Heating circuit sensor break The HK1 ST30 sensor or its cables are interrupted.	Contact a specialist company.
PF185	Combustion chamber sensor defective! (= Brennraum Fühler defekt!)	ST38 combustion chamber sensor Polarity reversal In the combustion chamber: The connection cables of the ST38 sensor are reversed.	Contact a specialist company.
PF186	Combustion chamber sensor defective! (= Brennraum Fühler defekt!)	ST38 combustion chamber sensor break The sensor or the cables on SR38 are interrupted.	Contact a specialist company.
PF191	Board temperature! (= Platinentemperatur!)	Boardtemperature too high The temperature on the control board is too high.	Contact the specialist company.
PF192	T-sensor circuit board defective! (= T-Sensor Platine defekt!)	Board temperature measurement defective. The sensor for measuring the board temperature is defective. The temperature is outside the measuring range (-20 /+100 °C).	Contact the specialist company.
PF201	Heat dissipation! (= Wärmeabfuhr!)	Heat dissipation because the boiler temperature is too high.	Contact the specialist company.
PF211	Outdoor sensor defective! (= Fühler Außen defekt!)	Outdoor sensor short circuit The outdoor sensor STP6 or its cables have a short circuit.	Contact a specialist company.
PF212	External sensor defective! (= Fühler Außen defekt!)	Outdoor sensor break The outdoor sensor STP6 or lines are interrupted.	Contact a specialist company.

Error code	Short text on the display	Description, causes	Note to the operator
PF215	HK2 sensor defective! (= HK2 Fühler defekt!)	Heating circuit 2 sensor short circuit The HK2 sensor on STP7 or its cables have a short circuit.	Contact a specialist company.
PF216	HK2 sensor defective! (= HK2 Fühler defekt!)	Heating circuit 2 sensor break The HK2 sensor on STP7 or lines are interrupted.	Contact the specialist company.
PF221	Level error! (= Fehler Füllstand!)	The fill level sensor may be covered. It reports that the container is full, although the container level indicates the message Refill container.	Clean the fill level sensor (see service manual). If the message appears again, contact a specialist company.
PF222	Lack of fuel! (= Brennstoffmangel!)	There are too few pellets in the combustion chamber . The combustion chamber temperature is too low or the oxygen content in the flue gases is too high for combustion.	Check whether the pellet container is empty. If so, provide new fuel. If not, contact a specialist company.
PF253	Empty the ash box! (= Aschebox leeren!)	The ash box is getting full and must be emptied soon . (information message).	Empty the ash box. After emptying, tap the ash box on the Home view display to reset the fill level.
PF254	Empty the ash box! (= Aschebox leeren!)	The ash box is full and must be emptied immediately . (An error message is displayed and the boiler is blocked).	Empty the ash box, otherwise it will not be possible to start the boiler. After emptying, tap the ash box on the Home view display to reset the fill level.
PF262	Grate motor running time (= Laufzeit Rostmotor)	Maximum running time of the grate motor exceeded	Contact the specialist company.
PF331	Suction fan speed error (= Drehzahl Saugzug Fehler)	ST55 Suction fan speed The deviation of the values for the ST55 suction fan speed is too high.	Contact the specialist company.
PF371	Filling incomplete (= Befüllung unvollständig)	The maximum suction time has been exceeded, the daily container is not full within this time.	Check the pellet store and suction system; contact a specialist company if necessary.
PF411	Valve defective! (= Ventil defekt!)	Heat exchanger flush valves defective or not connected	Contact the specialist company.
PF413	Lifting system fault! (= Störung Hebeanlage!)	Fault contact of the waste water lifting unit open (STP 8)	Clean lifting system, contact specialist company if necessary.
PF451	Slide-in unit error! (= Fehler Einschub!)	There is a blockage in the slide-in unit or the motor is defective or not plugged in!	Contact a specialist company.
PF601	Fuse Si3 defective (= Sicherung Si3 defekt)	Fuse Si3 (boiler pump ST10, DHW pump ST11, DHW cleaning ST12, room discharge ST20, HK2 pump STP4, mixer STP2) defective.	Contact the specialist company.

Error code	Short text on the display	Description, causes	Note to the operator
PF611	Fuse Si6 defective (= Sicherung Si6 defekt)	Fuse Si6 (suction draught ST18) has tripped.	Contact the specialist company.
PF621	Fuse Si5 defective (= Sicherung Si5 defekt)	Fuse Si5 (ignition ST17, PV power regulator ST14 and ash auger ST16) defective.	Contact the specialist company.
PF631	Fuse Si2 defective (= Sicherung Si2 defekt)	Fuse Si2 (suction turbine ST13) defective.	Contact the specialist company.
PF651	Fuse Si1 defective (= Sicherung Si1 defekt)	Fuse Si1 (230V mains) defective.	Contact the specialist company.
PF671	Fuse Si4 defective (= Sicherung Si4 defekt)	Fuse Si4 (water flush STP3, HK1 pump and mixer STP5) defective.	Contact a specialist company.
PF672	Hose diverter fuse (= Sicherung Schlauchweiche)	The fuse of the second pellet expansion board PEP2 (hose switch) has tripped.	Contact the specialist company.
PF801	Differential pressure low (= Differenzdruck niedrig)	Differential pressure sensor defective or not plugged in.	Contact the specialist company.
PF802	Differential pressure high (= Differenzdruck hoch)	Vacuum too high or differential pressure sensor defective.	Contact the specialist company.
PF803	Supply air flow low (= Zuluftstrom niedrig)	Combustion air flow low. Supply air duct blocked or boiler body not properly sealed (ash door, burner unit, cleaning cover).	Check supply air path, check ash door, contact specialist company
PF804	Supply air flow too low (= Zuluftstrom zu niedrig)	Air flow of combustion air too low. Supply air duct blocked, boiler body not properly sealed (ash door, burner unit, cleaning cover) or air hoses incorrectly or not connected.	Check supply air path, check ash door, contact specialist company
PF805	Air supply disrupted! (= Luftzufuhr gestört!)	Air supply disrupted during combustion. Air supply pipe blocked, ash door open or air hoses not connected correctly.	Close the ash door; contact a specialist company if necessary.

5.2 Acknowledge error messages BPH

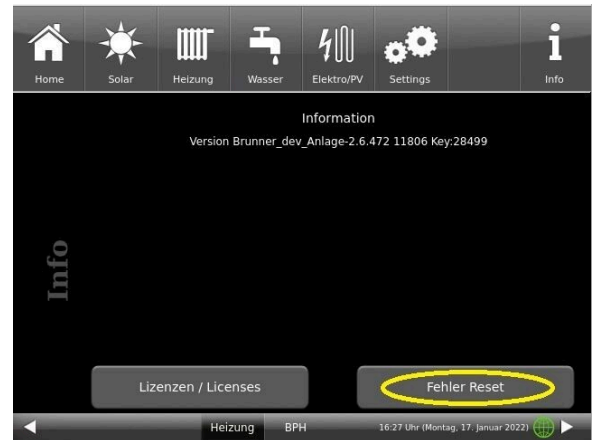
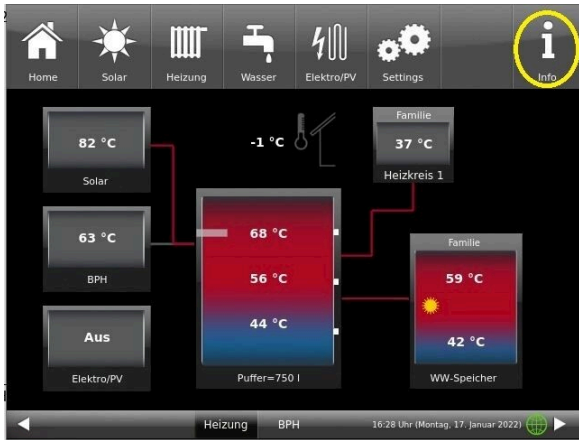

To **acknowledge an error message or a note**, proceed as follows:

1. tap the **Info** button;
2. In the lower half of the display press **Error Reset = Fehler Reset**
→ The error message was acknowledged.

If the error still exists, the error message appears again. The info button can also be highlighted in orange.

Error messages can only be acknowledged in the top menu bar of the home view in the Info submenu.

5.3 Communication of the system

The control can send you the information and messages of the system at the current time by e-mail. Therefore: **Settings** / Pin entry (9999) / System (**Anlage**) and switch by arrow to site 2 (Anlage 2). The E-Mail Notification (**E-Mail Benachrichtigung**) button is located here.



Illustration 27: System/Anlage site 1

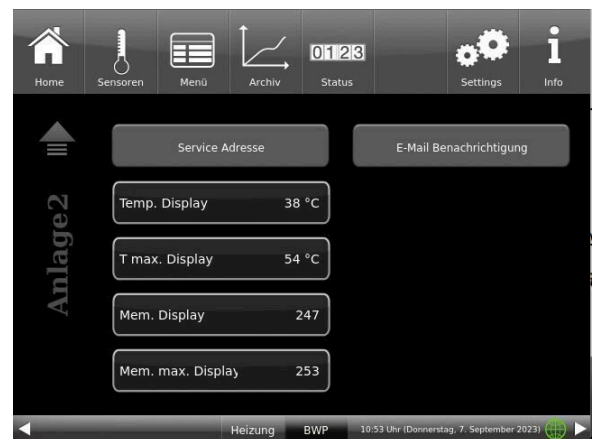

Illustration 28: System/Anlage site 2



If you are the operator (end customer) of the BRUNNER system click on the gray button next to "Kunde".

The highlighted field turns orange. When clicked the Subject button or Max@mustermann.de a keyboard field appears, using where you can enter your email address.



6 Cleaning and maintenance

Regular maintenance of the boiler BPH 7/24 und BPH 9/30 ensures environmentally friendly operation of the system and extends its service life. Regular maintenance enables potential or emerging damage to be detected at an early stage and rectified. This increases the operational reliability of the heating system. At the same time, possible energy wastage is prevented.

According to the regulation on energy-saving thermal insulation and energy-saving system technology in buildings (Energy Saving Ordinance - EnEV §11), the operator of a heating system is obliged to regularly maintain and service the heating system.



CAUTION

Observe all instructions on work safety.

Follow the instructions in the chapter “For your safety”.

The operator is recommended to **clean the casing** of the pellet boiler.

Proceed as follows:

- wipe and, if necessary, rub the cladding with a damp cloth.
Do not use any harsh or corrosive cleaning agents.
Caution! Excessive moisture can damage the electronics of the appliance.

6.1 Cleaning and maintenance intervals

Automatic cleaning

The most important points at which automatic cleaning takes place are Sliding grate, ash discharge and heat exchanger.

Recommendations

Regular cleaning leads to efficient and low-emission use of the energy used. This protects the environment and saves heating costs - while maintaining a high level of heating and hot water comfort.

	When?	Who?	What?
1	After each burn-off	takes place automatically	- Slide grate cleaning - Heat exchanger cleaning - Ash discharge
2	3 - 4 times a year	Operator	Empty ash box
3	annually	Specialist company	Maintenance work in accordance with the maintenance agreement and the service manual



We recommend annual monitoring of the system on the basis of a maintenance contract.

This results in:

- higher efficiency and a longer service life of the heating system combined with greater operational reliability;
- savings in heating costs and conservation of resources through efficient use of the energy used;
- a consistently high level of heating comfort.

Display messages on the need for maintenance work

To check the need for maintenance, proceed as follows

1. tap on **Status** and look at the coloring of the boxes next to the **Service** indication;

The coloring of the individual boxes results from the operating hours that have elapsed.



Illustration 29: Display: Maintenance required

The figures shown for the need for maintenance indicate **the percentage of the set** operating hours.

E.g. green boxes = from 0 to 60% of the operating hours scheduled for service have elapsed. 40% of the operating hours remain until you should contact a specialist company for service work.

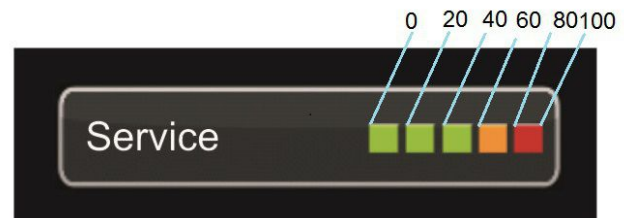

Illustration 30: Display: Maintenance intervals

As soon as the display is set to "red", a pop-up window appears with the corresponding information about cleaning or the need for service.

The specialist company will carry out the service work.

After each maintenance or service, you must confirm this process on the display. This is done by tapping the **O.K.** field . This resets the operating hours or the interval until maintenance is required.

6.2 Cleaning tool

After opening the maintenance door, you will see the cleaning brush.

Only use the brush supplied to clean the pellet boiler BPH 7/24 und BPH 9/30.



Warning

Damage to the appliance (pitting corrosion!)

Another brush, e.g. a steel brush, will damage the interior of the boiler.

Only use plastic brushes.

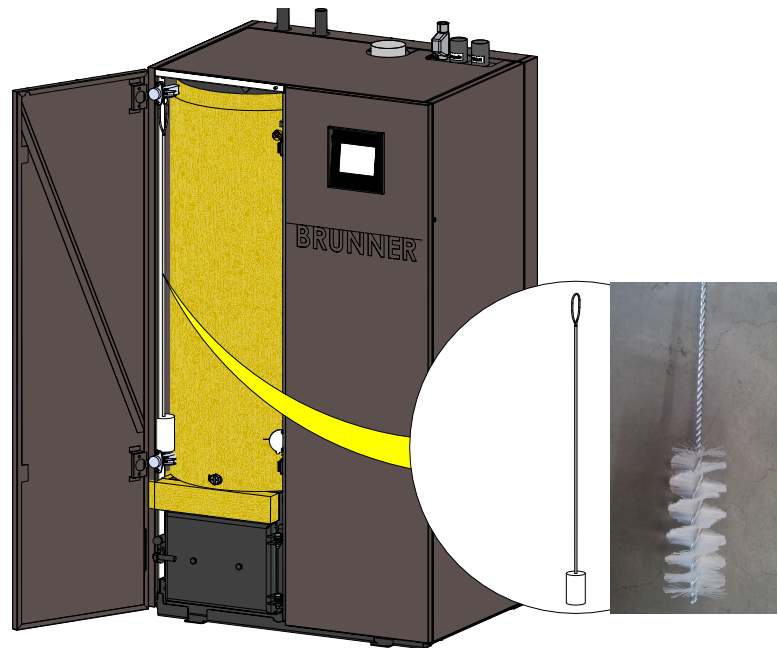

6.3 Emptying the ash box

When the ash box is full, the following messages appear on the display - depending on how full the ash box is:

1. message “ **Empty ash box (= Aschebox entleeren)** ” = please empty the ash box soon
2. error message “ **Ash box is full! Boiler is blocked until the ash box is emptied (= Aschebox ist voll! Kessel ist gesperrt bis die Aschebox geleert wird)** ” = Empty the ash box immediately.

Only empty the ash box when the boiler is in standby mode!

Use protective gloves!

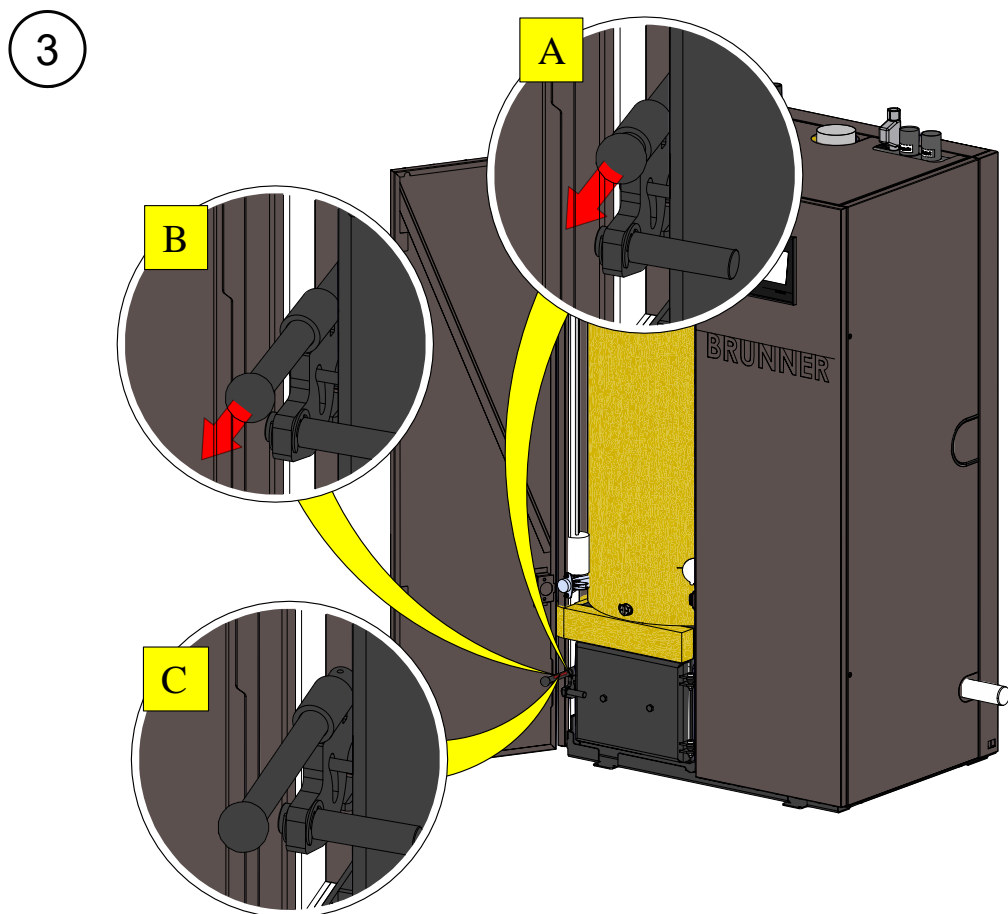
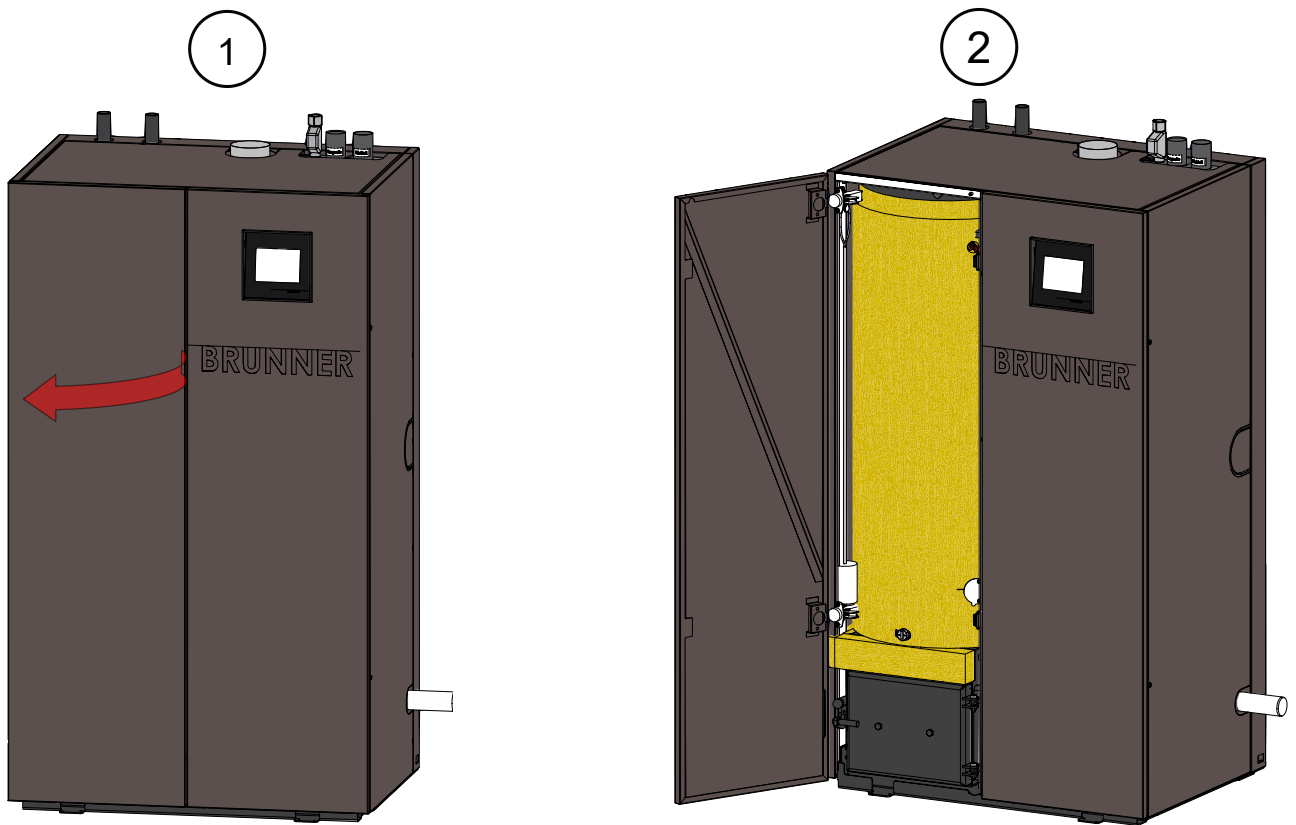

4

To ensure that the opening lever of the ash door remains fixed in its operating position, turn it 90 degrees.

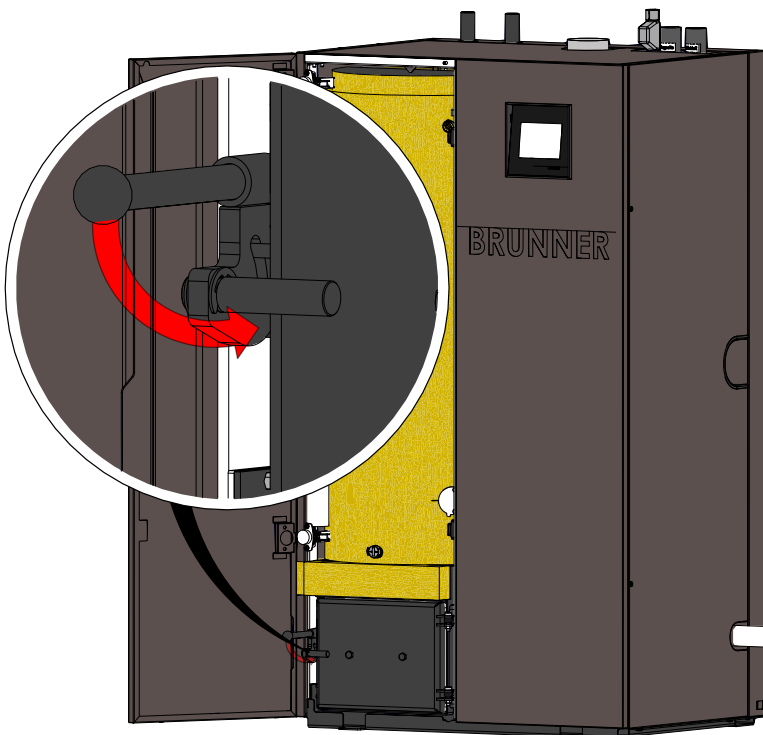
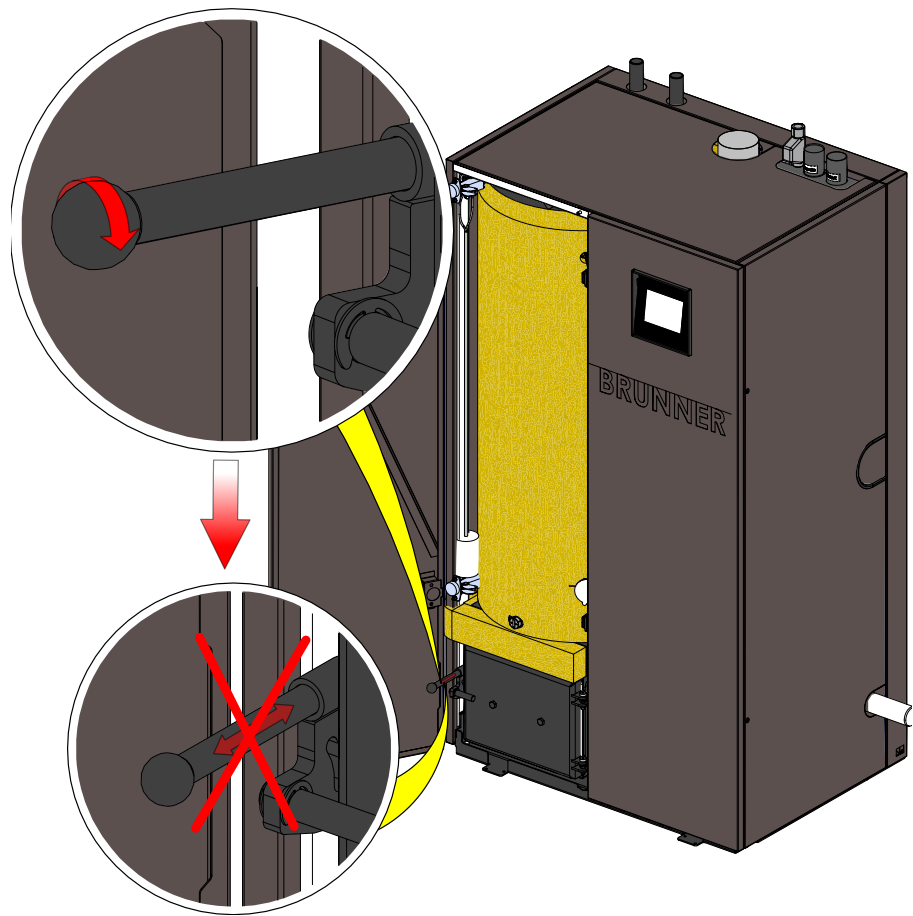

5

Press the ash door lever a little harder

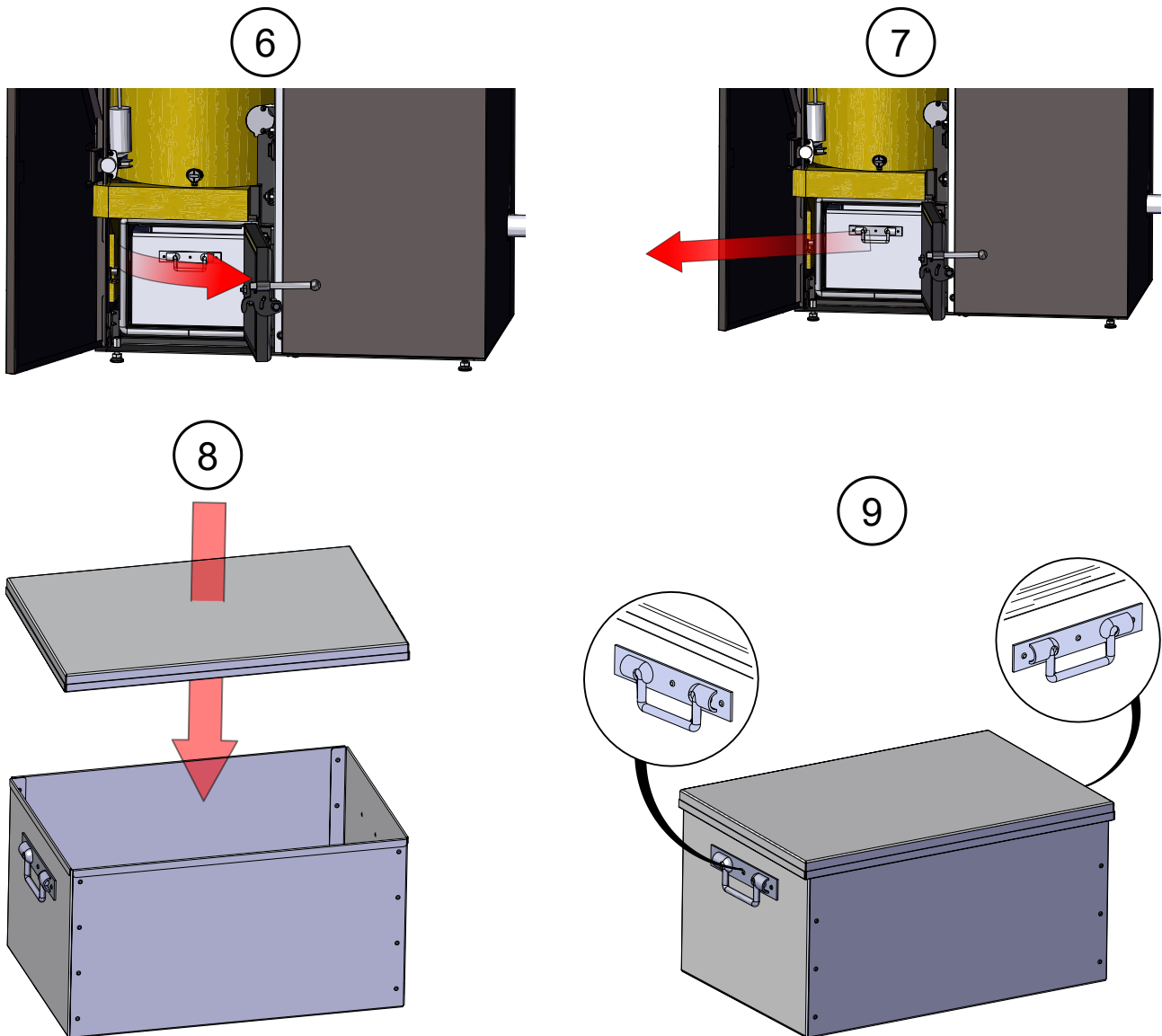

6.4 Ash disposal

Recommendations from the German Pellet Institute (DEPI information sheet Feb. 2016)

One of the advantages of heating with pellets is the low ash content, which requires only a few ash emptying operations per year and therefore contributes to the convenient operation of the system. The average ash content of ENplus A1 quality class pellets is 0.3 percent, with a maximum of 0.7 percent permitted. For the ENplus A2 quality class, which can be used in larger boiler systems, the limit value is 1.2 percent ash. Ashes must be recycled or disposed of in accordance with the Closed Substance Cycle Waste Management Act (KrWG). Due to the effective combustion in pellet boilers, the ash is almost completely carbon-free (burnt out) and therefore suitable for landfill. Whether wood ash (especially bottom ash) can be processed into a fertilizer or otherwise recycled instead of landfilled depends on the quality of the ash and is the responsibility of the waste disposal company. It should be noted that ashes should not be used directly and without processing as fertilizer in your own garden and may not be placed on the market.

Ash analyses and pollutant load

When disposing of ash, the waste disposal company may request an ash analysis. The type of analysis depends on the intended recycling or disposal method (fertilizer, landfill). If ash is used as a fertilizer, the analysis should be carried out in accordance with the Fertilizer Sampling and Analysis Ordinance (DüngMProbV). Critical parameters are the chromium (VI) limit value for grate ashes and the cadmium limit value for filter ashes. For disposal in landfills, the requirements of the Landfill Ordinance (DepV) apply. A critical parameter is the dissolved organic carbon (DOC) in the eluate, which can exceed the limit values for landfill class 3 in individual cases.

The ash from continuous operation should be used for the analysis and not from the commissioning of the plant, as the composition of the latter ash is not representative.

In the Waste Catalogue Ordinance (AVV), wood ash is listed under various waste code numbers. Firing with wood pellets mainly produces **bottom ash**, which is assigned the waste code number **10 01 01**. For smaller boiler systems with only one ash container, all of the ash produced is classified as bottom ash. As a rule, there are no special requirements for disposal and landfilling.



In general, the formation of dust clouds should be avoided when handling wood ash. Ash dust can irritate the skin and damage the respiratory tract. As a precautionary measure, it is recommended that face masks, gloves and safety goggles are worn to prevent the ingestion of dusty ash via the respiratory tract or mucous membranes.

Recommendations for the disposal of bottom ash

When handling bottom ash, disposal should be differentiated according to the system output or the annual ash production.

Disposal recommendations for bottom ash according to system output:

Heat output	Pellet consumption	Ash production	Disposal
< 100 kW	2-20 t/a	10-100 kg/a*	Disposal via household waste
100 - 300 kW	15-100 t/a	100-500 kg/a*	Collection in big bags
> 300 kW	> 100 t/a	> 500 kg/a*	Collection in big bags or skips

* The calculation is based on pellets of quality class ENplus A1

Recommendations for pellet furnaces up to 100 kW output (single and multi-family homes):

- the ash pan should be emptied regularly by the heating system operator. The **completely cooled grate ash** can be added to the household waste.
- The untreated ash should **not be used as fertilizer** on your own land, as this can lead to overfertilization and problems due to the strongly alkaline character of the ash and the accumulation of heavy metals.

6.5 Operation with electrostatic separator

The vertical BPH separator set (OTI) is available as an accessory.

For cleaning and maintenance, follow the manufacturer's instructions - Oekosolve AG.

6.6 Notes on the update

With the Software Update function it is possible to update the control unit.



INFO

During an update, the parameter settings from configuration and the later modified values are not getting lost.



ATTENTION

- **Only carry out the update when the fireplace is cold (stand by)!**
- **Updates must be carried out on every control display on the system!**

The update is made available as a zip file (* bin files).

During an update, both the values set during configuration and those set subsequently are adopted.



NOTE

The entire update process takes a few minutes (but can take up to 20 minutes for a single display with older display versions, so allow sufficient time. Depending on the system situation, the update may take longer)

The update process should not be interrupted. **DO NOT touch the display (touch field) during the entire update process.**

If the USB stick is faulty or does not contain the latest updates, the application starts as usual.

6.6.1 Software from PC on the USB-Stick

1. You will receive an email with a link -> click on the link:

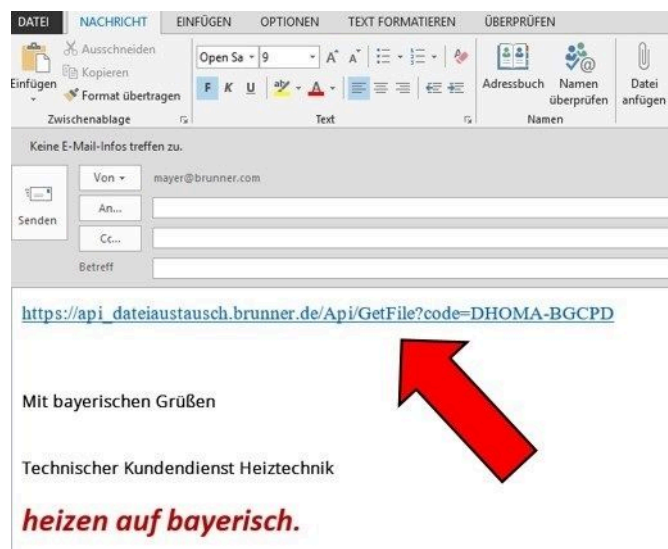

2. A dialog window opens in which you should click on **Datei speichern** (Save file)
3. Confirm with **OK**



4. The zip file is saved in the download area. Another storage location can possibly also be specified.

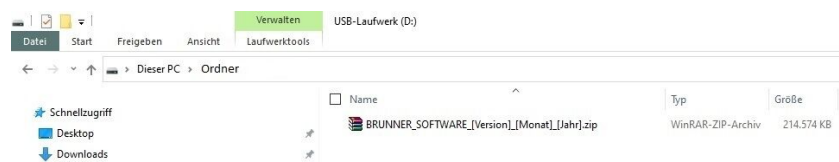

5. Now select the zip file with a right click and click on **Hier entpacken**

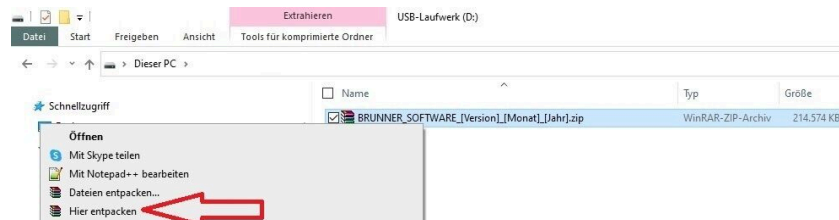

6. The unpacked files for updating the control unit are displayed:

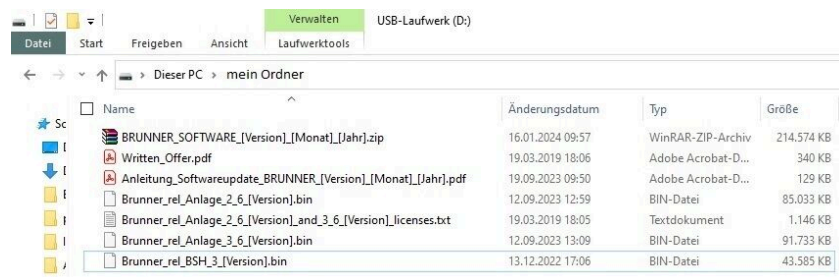

7. Copy the bin file or files to an empty USB stick (>500 MB).

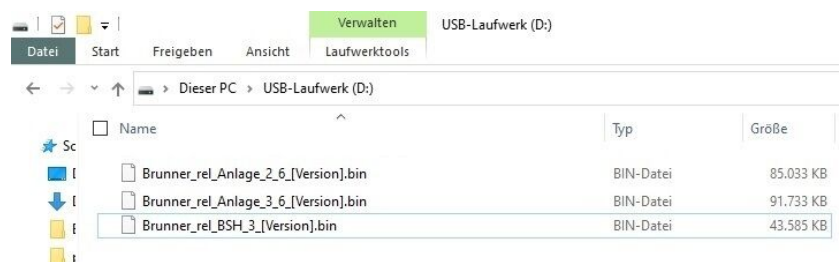

INFO: Only the .bin files are transferred to the USB stick. The documents enclosed for your information (in pdf or text format) are saved on your PC. The purpose of these text files is to inform you.

8. Remove the USB stick from the PC (**Auswerfen**).

-> The USB-Stick is ready for Update

6.6.2 Transfer the software from the USB stick to the control panel

Check again:

- Is the fireplace cold?
- Is the pellet, log boiler, BPH, BSV in "Standby" status and the boiler is **locked**? (Boiler > Menu > Locked)
- Is BWP in "**Standby**" status and operating mode "**OFF**" = **AUS** ? (BWP > Menu > Operating mode)

The main steps of update process are following:

1. remove the display from its holder
2. disconnect the power supply to the display (2-pin plug)
3. insert the USB stick **correctly** into the control unit (so that it is also recognized as a data carrier).
4. restore the power supply (2-pin plug);

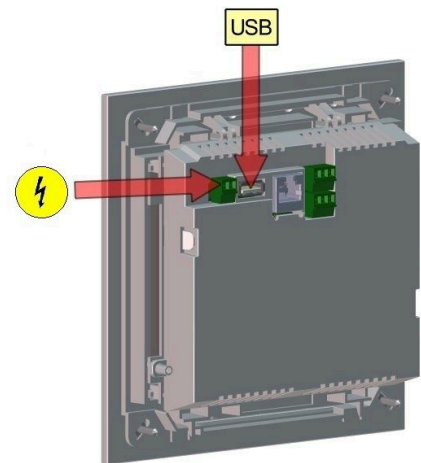

5. a current update is recognized and loaded when the control panel is started. The system performs an automatic restart and starts the loading process (display "red wave"; then "loading bars" appear) of the update. The successful installation of the update is indicated by the message "remove USB stick and reboot".

6. remove the USB stick from the control panel

7. control board and control panel (display "red wave") automatically start with a reboot. After the restart, the control unit is updated. After the system update has finished, the update process is automatically completed with the data synchronization.

Restarting the system

1. disconnect the complete system from the mains supply for approx. 3 seconds
2. restore the mains supply to the complete system, after the restart the system is ready for operation.
3. reactivate the boiler and heat pump
4. check that the system is functioning correctly.

6.6.3 What to do if the update does not start?

Check your USB-Stick

- Check whether the USB stick is correctly inserted in the display

- The zip file must be unpacked after the download. The software file contained in the package with the extension Brunner_rel_Anlage_x_x_xxx.bin must be contained on the top level of the data carrier.

- You may have already installed the latest software version.

How to find out which software version is running on your control unit: To do this, please press the “Info” button on the top right of the screen.

If it still does not work, please check whether it is a “Display Touch 2.0” resp. 3.0 “acts. If you have an older version, please contact our customer service. Please indicate the item number of the display and the currently installed software version (see picture). The article number can be found on the back of the display printed on the sticker (article no.Exxxxxx).



*Illustration 31: z.B. bei einer neueren Software-Version**

*To determine the last version status - if you do not receive this information by pressing the **Info** button - proceed as follows :

a) **Settings > Anlage** and button **Version**

or:

b) **Settings > Anlage** and button **Version**

7 Decommissioning

7.1 Temporarily take the boiler out of operation



CAUTION

Possible damage to property due to frost

If the boiler BPH 7/24 und BPH 9/30 is temporarily taken out of operation, there is a risk of frost damage.

- Ensure that the boiler is not damaged by frost.

You can take the boiler out of operation temporarily, e.g. during long periods of absence.

To take the boiler out of operation temporarily, proceed as follows:

1. burn out the boiler and allow it to cool down.
2. disconnect the boiler from the power supply = press the emergency heating switch.

→ The boiler is out of operation.

To put the boiler back into operation, press the emergency heating switch.



If the boiler BPH 7/24 und BPH 9/30 is operated in conjunction with the BRUNNER central heating system (BHZ), the boiler must not be disconnected from the power supply for temporary decommissioning.

An interruption of the mains voltage leads to error messages on the existing operating displays of other heating devices within the BRUNNER network environment (e.g. BRUNNER central heating system (BHZ), EOS tiled stove control unit).

7.2 Decommissioning the boiler

To decommission the boiler permanently (e.g. preparation for dismantling and disposal), proceed as follows:

1. burn out the boiler and allow it to cool down;
2. press the emergency heating switch → to disconnect the boiler from the power supply.
3. drain the boiler completely;

→ The boiler BPH 7/24 und BPH 9/30 is put out of operation.

7.3 Waste disposal



Danger

Possible personal injury due to improper dismantling

Dismantling the boiler BPH 7/24 und BPH 9/30 requires extensive specialist knowledge.

- Dismantling may only be carried out by an authorized specialist company.



DANGER

Danger to life due to electric shock

The electrical connections of the boiler are live. This can lead to an electric shock.

- Only a qualified tradesman may dismantle the electrical installation.
- Switch off the power supply.
- Secure the power supply against being switched on again.

7.3.1 Disposing of packaging

The specialist company that installed the boiler is responsible for disposing of the transport packaging.

7.3.2 Disposing of boilers

The boiler BPH 7/24 und BPH 9/30 and its accessories are largely made of recyclable materials.

The body of a boiler is made of metal. Boilers also contain valves, seals with plastic and rubber parts and electronic components (e.g. boiler controls, drives, fans, power cables).

Summary of recycled products: Steel (including stainless steel), metal, plastic, plastics, rubber, circuit boards (may contain platinum and beryllium), copper.

Neither boilers nor accessories may be disposed of with household waste.



Observe the applicable national legal regulations for disposal.

Ulrich Brunner GmbH is listed in the EAR Foundation under WEEE no. DE75509764.

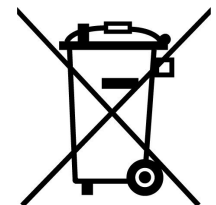

8 Technical and commercial data

8.1 Declaration of Conformity BPH

EG-Konformitätserklärung

Hersteller: Ulrich Brunner GmbH
Zellhuber Ring 17-18
D-84307 Eggenfelden

Produkt: Holzpellet-Heizkessel

Typen: BPH 4/15, BPH 4/17
BPH 7/24, BPH 7/25
BPH 9/30, BPH 9/32

EU-Richtlinien: 2006/42/EG (Maschinenrichtlinie)
2014/30/EU (EMV-Richtlinie)
2014/35/EU (Niederspannungsrichtlinie)
2011/65/EU (RoHS-Richtlinie)
2015/1189/EU (Richtlinie über Ökodesign-Anforderungen an Heizkessel für feste Brennstoffe)

Angewandte Normen:
EN-303-5: 2012
EN ISO 12100: 2011
EN 60335-2-102: 2016-09
EN 61000-6-1: 2007
EN 61000-6-3: 2007/A1: 2011
EN 61000-3-2: 2014
EN 61000-3-3: 2013

Wir erklären, dass das Produkt in den hier angegebenen Standardausführungen den oben genannten Bestimmungen entspricht.

Eggenfelden, den 06.12.2021

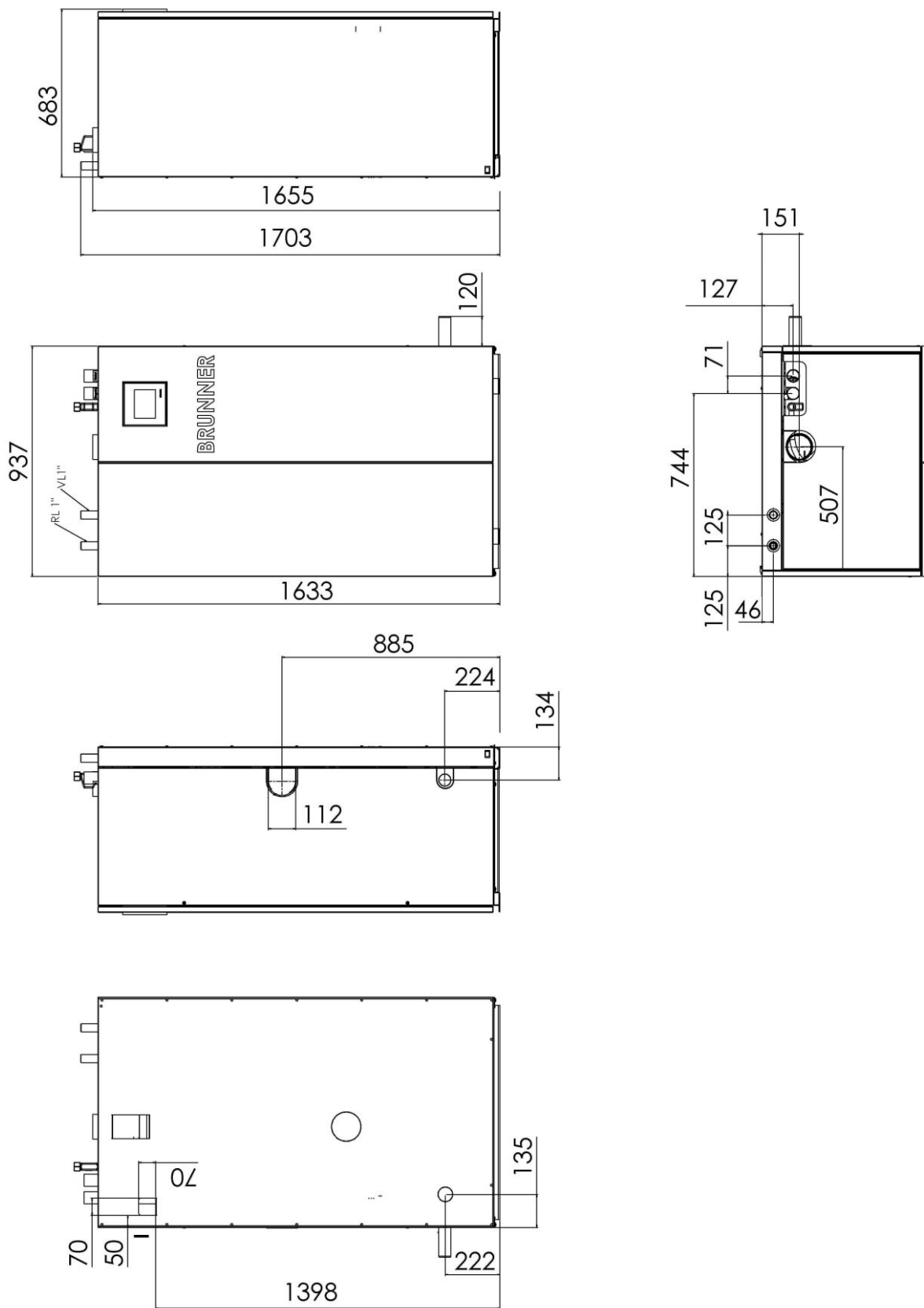

Hubertus Brunner
Geschäftsführer

8.2 Dimension sheets

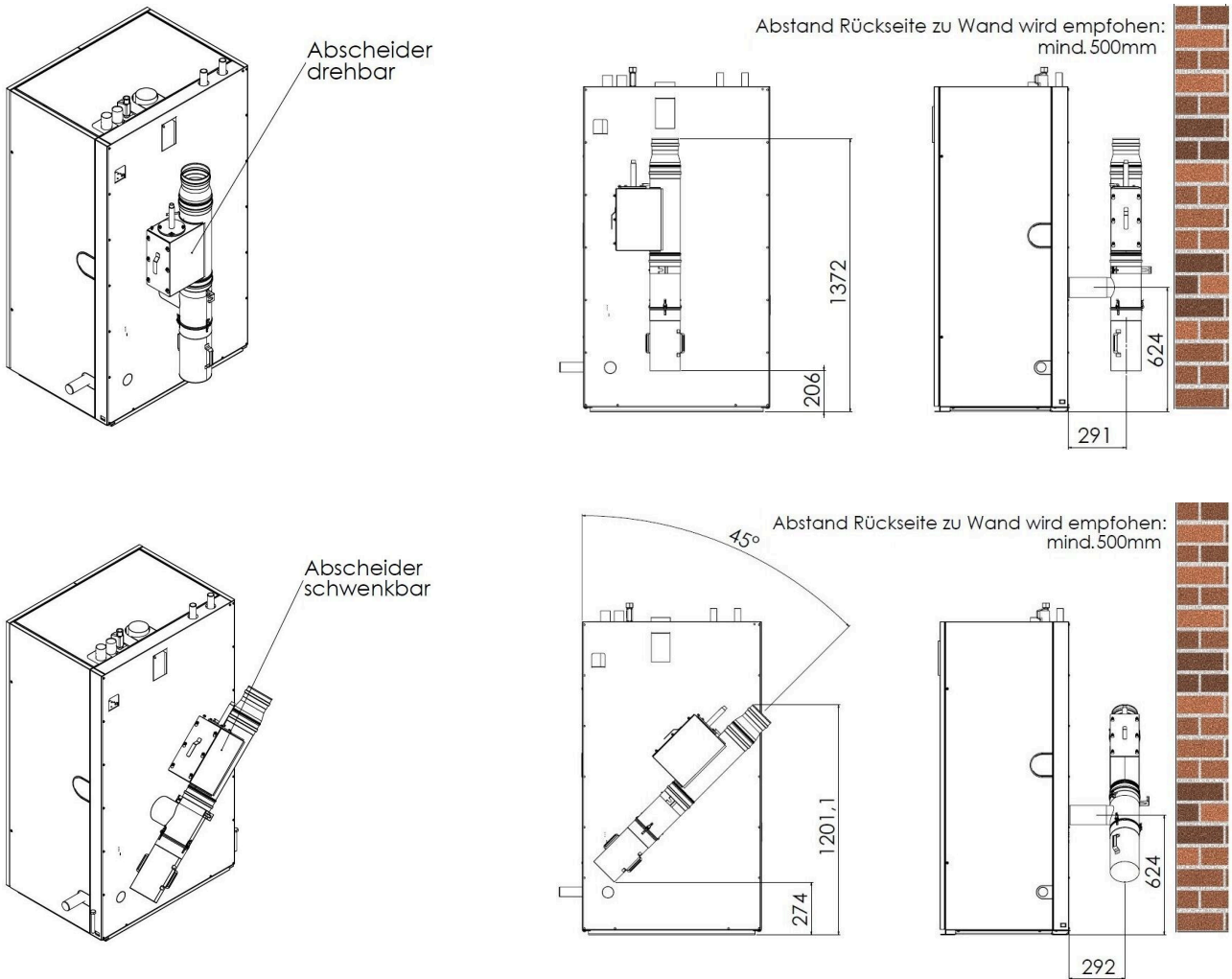

8.2.1 BPH separator (UE10160)

Separator with BPH 7/24 or BPH 9/30:



8.3 Technical data BPH 7/24 and BPH 9/30

Parameter	UM	BPH 7/24	BPH 9/30
Operational mode		heat value, non-condensing	heat value, non-condensing
Heat output range	kW	7 - 24	9 - 30
Boiler efficiency Nominal heat output	%	93,3	94,2
Boiler class (EN 303-5/2012)		5	5
Operating pressure	bar	3	3
Dimensions			
Dimension boiler with sheeting (w x d x h)	mm	937 x 673 x 1633	937 x 673 x 1633

Parameter	UM	BPH 7/24	BPH 9/30
Mounting dimension boiler-body (w x d x h)	mm	927 x 660 x 1570	927 x 660 x 1570
Mounting weight boiler-body, min.	kg	250	250
Total weight	kg	370	370
Pellet weight in the day container	kg	55	55
Ash-tank drawdown	per year	3 - 4	3 - 4
Duration of burning (at nominal load)	h	6,5	6
Recomanded buffer storage volume, min.	liter	750	1000
Data on water connections			
Boiler water content	liter	78	78
Connector flow/return Ø	DN (Zoll)	AG 25 (1")	AG 25 (1")
Size MAG (expansion vessel)	liter	-	-
Boiler flow temperature, max.	°C	75	75
Boiler return temperature, min.	°C	35	35
Height flow	mm	1703	1703
Height return	mm	1703	1703
Water-side resistance $\Delta T=20K$	mbar	5,1	6,5
Water-side resistance $\Delta T=10K$	mbar	18,0	19,0
Height floor drain / condensate drain	mm	223	223
Connection of heat exchanger flushing	Zoll	IG 3/4"	IG 3/4"
Line dimension up to BHZ / buffer tank	DN (Zoll)	25 (1") / 25 (1")	25 (1") / 25 (1")
Data for chimney calculation (DIN EN 13884-1)			
Exit gas temperature nominal capacity	°C	125	125
Exit gas temperature part load	°C	120	120
Flue gas mass flow nominal capacity	kg/h (g/s)	46,8 (13,0)	54,0 (15,0)
Flue gas mass flow part load	kg/h (g/s)	17,3 (4,8)	21,6 (6,0)
Height exhaust pipe connection	mm	1658	1658
Exhaust pipe connection Ø	mm	100	100
Necessary delivery pressure	Pa	3	3
Available delivery pressure	Pa	-	-
Combustion air connection set Ø	mm	110	110
Height of combustion air connection (break-through in cladding)	mm	885	885
Permitted type of installation with RLU mode of operation		FC _{42x} and FC _{52x}	FC _{42x} and FC _{52x}
Content CO ₂	%	15,6	15,9

Note on exhaust gas routing

In the case of room air-independent operation, the connection line must generally be at least 50 Pa over-pressure-tight. We recommend our connecting line system.
When renovating, we recommend our SET chimney renovation.

Note on combustion air routing for room air-independent installationThe BPH has been tested for room air-independent operation in accordance with installation types **FC_{42x}** and **FC_{52x}** . The use of the “external supply air accessory pack”, item no. PH003060 is required for this type of installation!

Electric connection	M.E.	BPH 7/24	BPH 9/30
Power supply	VAC, A, Hz	230, 16, 50	230, 16, 50
Power input at nominal load	W	97	106
Standby	W	12	12

Emission parameters

	UM	BPH 7/24	BPH 9/30
Emissions according to the requirements for Germany-1.BImSchV; bei 13%O₂			
CO at nominal heat output	mg/m ³	8	12
CO at part load	mg/m ³	13	16
Dust at nominal heat output	mg/m ³	8	6
Dust at part load	mg/m ³	4	6
Dust at nominal heat output with OekoTube-Inside	mg/m ³	0,1	0,4
OGC at nominal heat output	mg/m ³	1	1
OGC at part load	mg/m ³	1	1
NOx at nominal heat output	mg/m ³	77	90
NOx at part load	mg/m ³	73	86
Emissions according to the requirements for Switzerland -LRV; bei 13%O₂			
CO at nominal heat output	mg/m ³	8	12
CO at part load	mg/m ³	13	16
Dust at nominal heat output	mg/m ³	8	6
Dust at part load	mg/m ³	4	6
OGC at nominal heat output	mg/m ³	1	1
OGC at part load	mg/m ³	1	1
NOx at nominal heat output	mg/m ³	77	90
NOx at part load	mg/m ³	73	86
Emissions according to the requirements for Austria-Art.15a; bei 13%O₂			

	UM	BPH 7/24	BPH 9/30
CO at nominal heat output	mg/MJ	5	8
CO at part load	mg/MJ	8	10
Dust at nominal heat output	mg/MJ	5	4
Dust at part load	mg/MJ	3	4
OGC at nominal heat output	mg/MJ	0	0
OGC at part load	mg/MJ	1	1
NOx at nominal heat output	mg/MJ	54	58
NOx at part load	mg/MJ	47	56

Specific parameters

	UM	BPH 7/24	BPH 9/30
For calculating the generator expenditure figures according to EnEV or DIN V 4701-10			
Efficiency in static operation		0,93	0,94
Efficiency in the basic cycle GZ		0,85	0,86
Useful heat given off by the heat generator during a basic cycle	kWh	14,64	18,30
Power share heating circuit		1	1
Max. usage performance in operation Qnmax	kW	24	30
Average usage performance in operation QNmax	kW	21,6	27
Temperature hysteresis	K	20	20
Auxiliary energy demand basic cycle QHE, GZ	kWh	0,059	0,065
Mean electrical power consumption in stat. operation	W	97	106
To calculate the generator expenditure figures according to EnEV or DIN 18599			
Standby loss at an average boiler temperature of 70 °C		0,011	0,011
Load on which the heat generator test is based (= part load)		0,29	0,30
Boiler temperature in the test case at nominal load	°C	75,0	75,0
Boiler temperature in the test case at part load	°C	75,0	75,0

Information according to the Delegated Regulation (EU) 2015/1187		BPH 7/24	BPH 9/30
Energy efficiency class		A+	A++
Rated heat output	kW	24	30
Energy efficiency index EEI		124	126

Information according to the Delegated Regulation (EU) 2015/1187		BPH 7/24	BPH 9/30
Annual use efficiency of space heater	%	82	82
Special precautions		-	-

Information according to (EU) 2015/1189		BPH 7/24	BPH 9/30
Heating mode		automatically	automatically
Recommended buffer volume	liter	750	1000
Condensing boiler		no	no
Solid fuel boiler with cogeneration		no	no
Combination heater		no	no
Exclusive fuel		Pure wood pellets according to EN 17225-2, class A1	Pure wood pellets according to EN 17225-2, class A1
Other suitable fuels		no	no
Emitted useful heat at nominal heat output (P_n)	kW	24,0	30,0
Emitted useful heat at 30% of the nominal heat output (P_p)	kW	7,2	9,0
Fuel efficiency at nominal heat output (η_n)	%	86,4	87,2
Fuel efficiency at 30% of nominal heat output (η_p)	%	87,8	87,6
Auxiliary power consumption at nominal heat output ($e_{l_{max}}$)	kW	0,097	0,106
Auxiliary power consumption at 30% of the nominal heat output ($e_{l_{min}}$)	kW	0,055	0,076
Auxiliary power consumption in standby mode (P_{SB})	kW	0,012	0,012

Annual space heating emissions (related to 10% O ₂ , dry flue gas, 0°C, 1013 mbar)			
PM	mg/m ³	7	8
OGC	mg/m ³	1	1
CO	mg/m ³	17	21
NO _x	mg/m ³	102	119

Testing and approval by testing institutes

Our products have been adequately tested and approved by recognized testing institutes. We will be happy to send you the respective reports if required.

Ulrich Brunner GmbH

Zellhuber Ring 17-18
D-84307 Eggenfelden

Tel.: +49 (0) 8721/771-0

E-Mail: info@brunner.de

Current data: www.brunner.de

BRUNNER products are offered and sold exclusively by qualified dealers and service centres.

Technical and range-related changes as well as errors reserved.

All images may contain additional functions or special equipment that are subject to a surcharge. Reprinting and duplication, including extracts, only with the express permission of the publisher. © Ulrich Brunner GmbH. © by Ulrich Brunner GmbH.

® **BRUNNER** is a registered trademark.

Doku-Nr.: 202827